

TKS

Tel Kablo Kanalları
Wire Mesh Cable Trays

A P E X M E T A L C A B L E T R A Y S Y S T E M S



TKS Serisi / Serie

ve Aksesuarlar
and Accessories

TKS

Tel Kablo Kanalları Wire Mesh Cable Trays

TKS

Sayfa No Page No	İNDEKS / INDEX
TKS 01	Tel Örgü Kablo Kanalı h:35mm / <i>Wire Mesh Cable Trays h:35mm</i>
TKS 02	Tel Örgü Kablo Kanalı h:55mm / <i>Wire Mesh Cable Trays h:55mm</i>
TKS 03	Tel Örgü Kablo Kanalı h:105mm / <i>Wire Mesh Cable Trays h:105mm</i>
TKS 04	Tel Örgü Kablo Kanalı Ek Elemanı-konsola Sabitleme Elemanı <i>Wire Mesh Cable Trays Joint Pieces - Wire Mesh Cable Trays Fixing Unit For The Bracket</i>
TKS 05	Uygulama Örnekleri / <i>INSTALLATION Examples</i>
TKS 06	Uygulama Örnekleri / <i>INSTALLATION Examples</i>
TKS 07	Uygulama Örnekleri / <i>INSTALLATION Examples</i>

TKS SERİSİ / SERIE

TKS Serisi / Serie

Sipariş Kodu (Order Code)	w (mm)	h (mm)	t (mm)	Kg/Mt (Kg/Mt)
AP-05TKI.35	50	35	4,00	0,381
AP-10TKI.35	100	35	4,00	0,523
AP-15TKI.35	150	35	4,00	0,665
AP-20TKI.35	200	35	4,00	0,808
AP-25TKI.35	250	35	4,00	0,951
AP-30TKI.35	300	35	4,00	1,093
AP-40TKI.35	400	35	4,00	1,378
AP-50TKI.35	500	35	4,00	1,664
AP-60TKI.35	600	35	4,00	1,949

h:35

TEL ÖRGÜ KABLO KANALI
WIRE MESH CABLE TRAYS

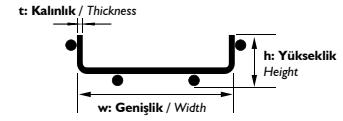
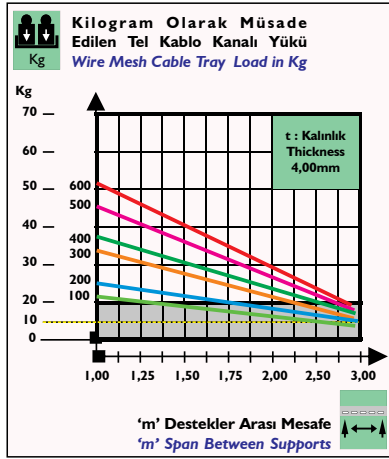
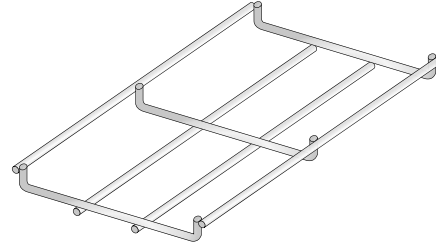

► AÇIKLAMALAR / INSTRUCTIONS :

Not: Standart uzunluk 3000mm.

! Tel kanallarda ölçü toleransı ± 3 mm.'dir.

Note: Standart length is 3000mm.

! The dimension tolerance in Wire Mesh Cable Trays is ± 3 mm

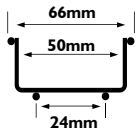

w: Genişlik / Width : 50mm

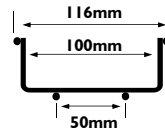

w: Genişlik / Width : 100mm

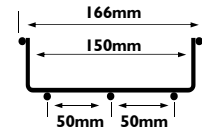

w: Genişlik / Width : 150mm

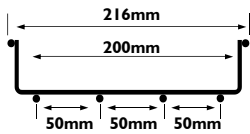

w: Genişlik / Width : 200mm

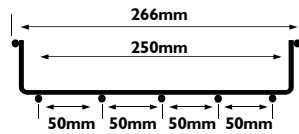

w: Genişlik / Width : 250mm

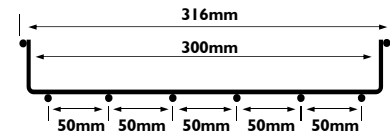

w: Genişlik / Width : 300mm

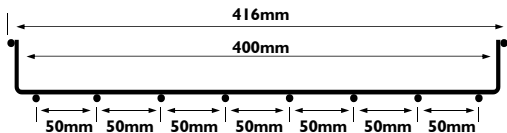

w: Genişlik / Width : 400mm

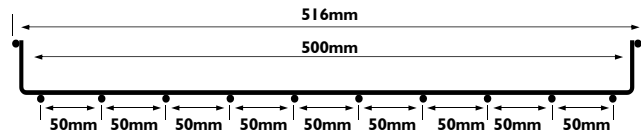

w: Genişlik / Width : 500mm

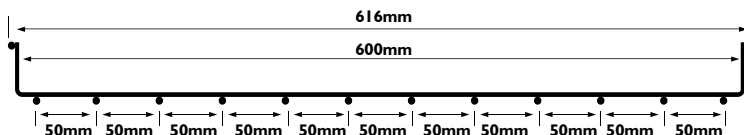

w: Genişlik / Width : 600mm

Sipariş Kodu (Order Code)	w (mm)	h (mm)	t (mm)	Kg/Mt (Kg/Mt)
AP-05TKI.55	50	55	4,00	0,651
AP-10TKI.55	100	55	4,00	0,793
AP-15TKI.55	150	55	4,00	0,935
AP-20TKI.55	200	55	4,00	1,076
AP-25TKI.55	250	55	4,00	1,218
AP-30TKI.55	300	55	4,00	1,360
AP-40TKI.55	400	55	4,00	1,643
AP-50TKI.55	500	55	4,00	1,926
AP-60TKI.55	600	55	4,00	2,210

TEL ÖRGÜ KABLO KANALI
WIRE MESH CABLE TRAYS

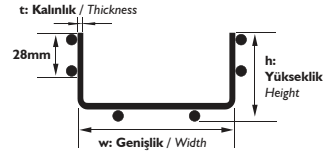
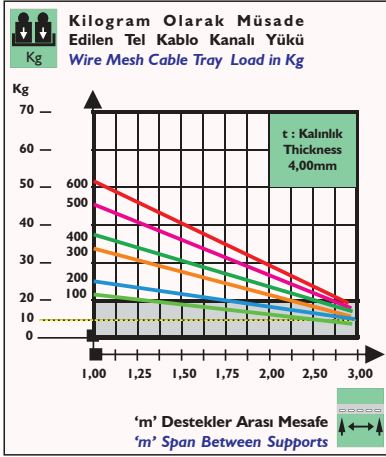
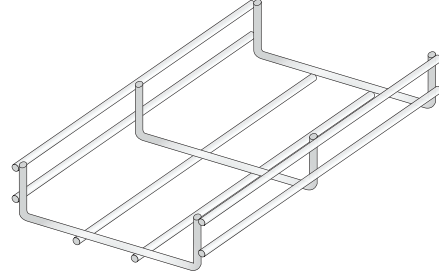

AÇIKLAMALAR / INSTRUCTIONS :

Not: Standart uzunluk 3000mm.

! Tel kanallarda ölçü toleransı ± 3 mm.'dir.

Note: Standart length is 3000mm.

! The dimension tolerance in Wire Mesh Cable Trays is ± 3 mm

TKS

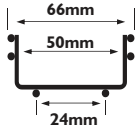

w: Genişlik / Width : 50mm

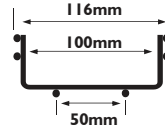

w: Genişlik / Width : 100mm

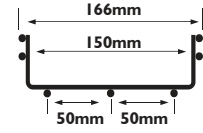

w: Genişlik / Width : 150mm

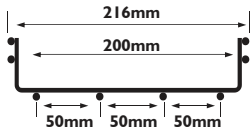

w: Genişlik / Width : 200mm

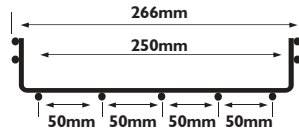

w: Genişlik / Width : 250mm

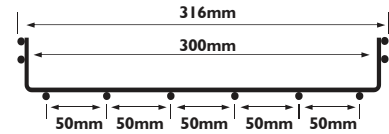

w: Genişlik / Width : 300mm

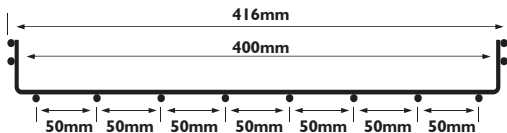

w: Genişlik / Width : 400mm

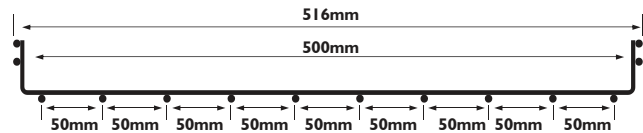

w: Genişlik / Width : 500mm

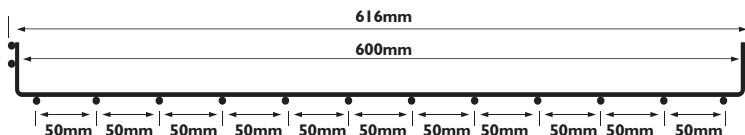

w: Genişlik / Width : 600mm

Sipariş Kodu (Order Code)	w (mm)	h (mm)	t (mm)	Kg/Mt (Kg/Mt)
AP-10TK1.105	100	105	4,00	1,050
AP-15TK1.105	150	105	4,00	1,118
AP-20TK1.105	200	105	4,00	1,331
AP-25TK1.105	250	105	4,00	1,474
AP-30TK1.105	300	105	4,00	1,616
AP-40TK1.105	400	105	4,00	1,901
AP-50TK1.105	500	105	4,00	2,187
AP-60TK1.105	600	105	4,00	2,472

TEL ÖRGÜ KABLO KANALI
WIRE MESH CABLE TRAYS

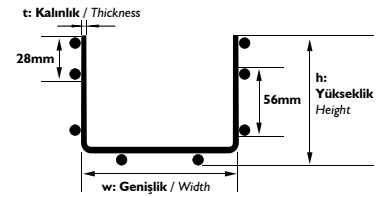
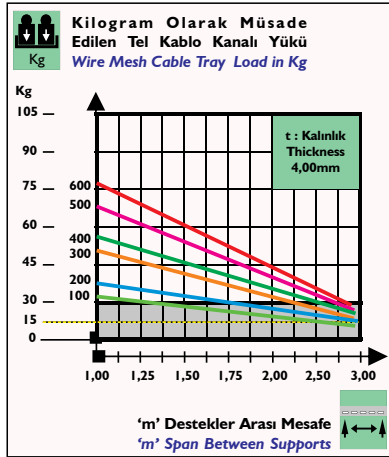
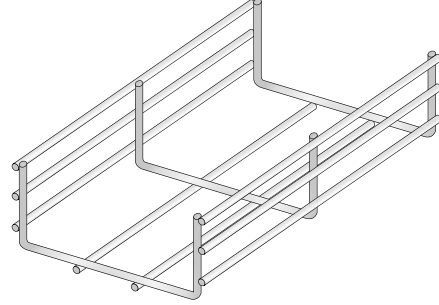

► AÇIKLAMALAR / INSTRUCTIONS :

Not: Standart uzunluk 3000mm.

! Tel kanallarda ölçü toleransı ± 3 mm.'dir.

Note: Standart length is 3000mm.

! The dimension tolerance in Wire Mesh Cable Trays is ± 3 mm

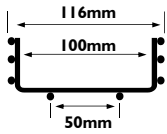

w: Genişlik / Width : 100mm

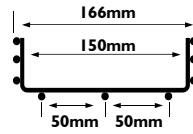

w: Genişlik / Width : 150mm

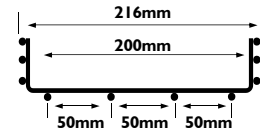

w: Genişlik / Width : 200mm

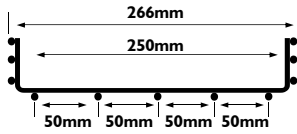

w: Genişlik / Width : 250mm

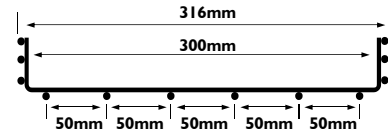

w: Genişlik / Width : 300mm

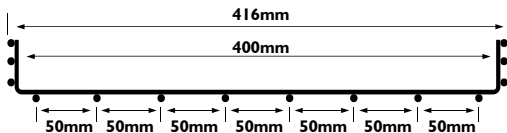

w: Genişlik / Width : 400mm

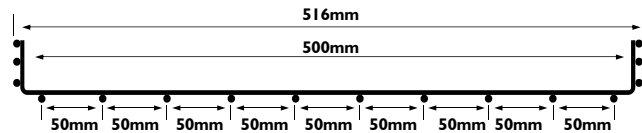

w: Genişlik / Width : 500mm

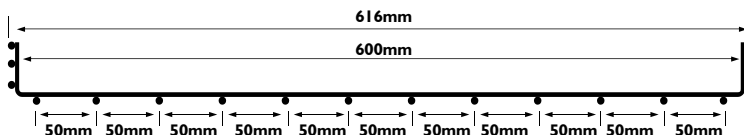

w: Genişlik / Width : 600mm

Sipariş Kodu (Order Code)	w (mm)	b (mm)	t (mm)
AP-TKB1	45	30	2,00

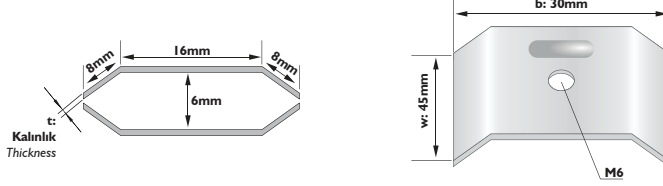
TEL ÖRGÜ KABLO KANALI EK ELEMANI
 WIRE MESH CABLE TRAYS JOINT PIECES

Sipariş Kodu (Order Code)	w (mm)	a (mm)	b (mm)	t (mm)
AP-TKB1-Y	40	22	50	2,00

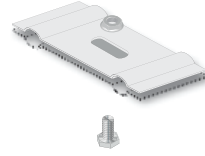
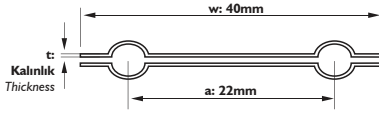
TEL KANAL ASKI KONSOLA TESPİT ELEMANI
 WIRE MESH CABLE TRAYS FIXING UNIT FOR THE

Sipariş Kodu (Order Code)	w (mm)	a (mm)	b (mm)	t (mm)
AP-TKB2-Y	70	50	50	2,00

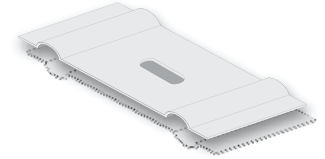
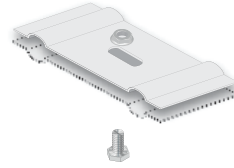
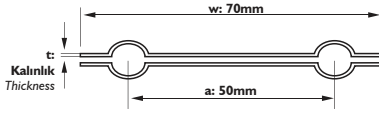
TEL KANAL ASKI KONSOLA TESPİT ELEMANI
 WIRE MESH CABLE TRAYS FIXING UNIT FOR THE BRACKET

TKS

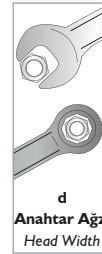
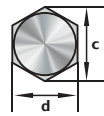
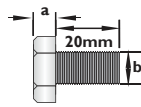
Sipariş Kodu (Order Code)	Açıklama (Explanation)
AP-CM6X20 AB	M6X20 A. B. CIVATA - M6X20 HEXAGON BOLT

ALTI KÖŞE BAŞLI CIVATA
 HEXAGON HEAD BOLT

a Boyun Yüksekliği / Neck Height (mm)	b Anma Çapı / Thread Size (Metrik - Metrical)	c Boyun Genişliği / Neck Width (mm)	d Kafa Çapı / Head Dia (mm)
3,85	6	11,05	10,00

d
 Anahtar Ağzı
 Head Width

Sipariş Kodu (Order Code)	Açıklama (Description)
AP-SFM6	FLANŞLI M6 SOMUN - M6 FLANGED NUT

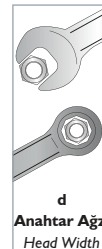
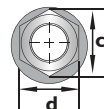
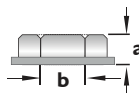
FLANŞLI SOMUN
 FLANGED NUT

a Yükseklik / Height (mm)	b Anma Çapı / Thread Size (Metrik - Metrical)	c Köşegen / Diagonal (mm)	d Anahtar Ağzı / Head Width (mm)
5,70	6	9,78	10,00

d
 Anahtar Ağzı
 Head Width

Radüslü Yatay 90° Dönüşler / 90° Bend

w Genişlik / Width (mm)	b Ölçü / Size (mm)	R İç Çap / Inner Diameter (mm)	L Uzunluk / Length (mm)
100	530x530	230	700
150	650x650	300	900
200	660x660	260	1100
300	940x940	440	1300
400	1060x1060	460	1700
500	1310x1310	610	2100
600	1370x1370	570	2500

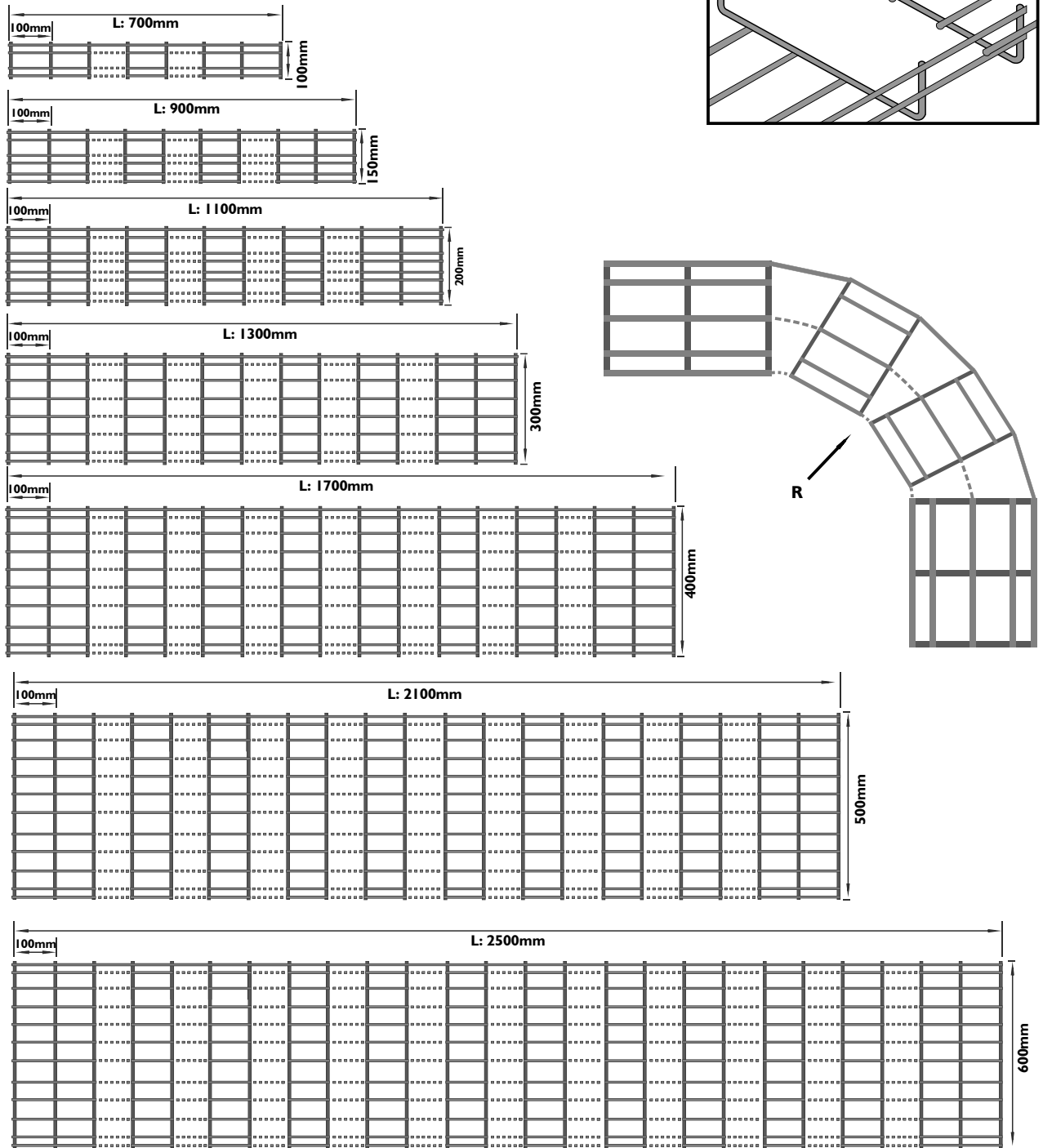
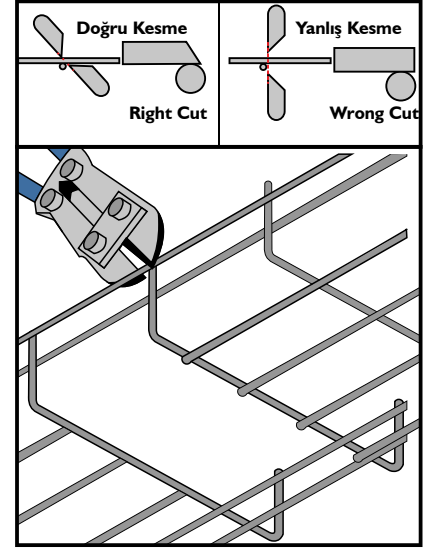

Radüslü Yatay 90° Dönüşler / 90° Bend

w Genişlik / Width (mm)	b Ölçü / Size (mm)	R İç Çap / Inner Diameter (mm)	L Uzunluk / Length (mm)
100	370x370	35	700
150	370x370	115	700
200	430x430	120	800
300	530x530	120	1000
400	630x630	120	1200
500	730x730	120	1400
600	830x830	120	1600

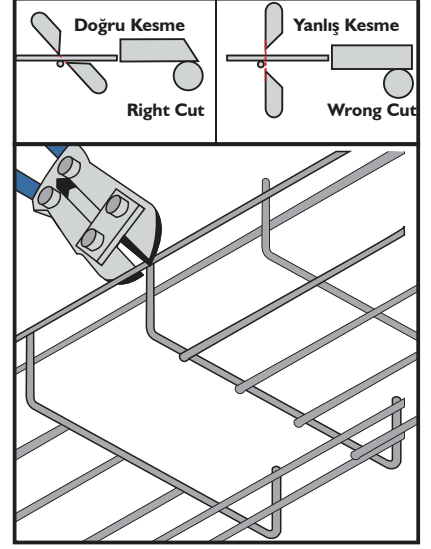
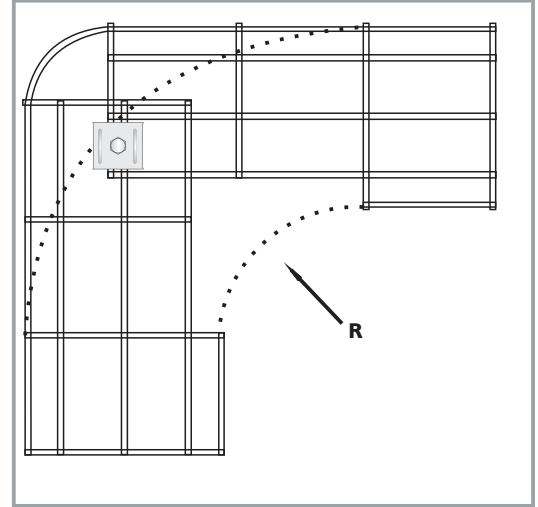
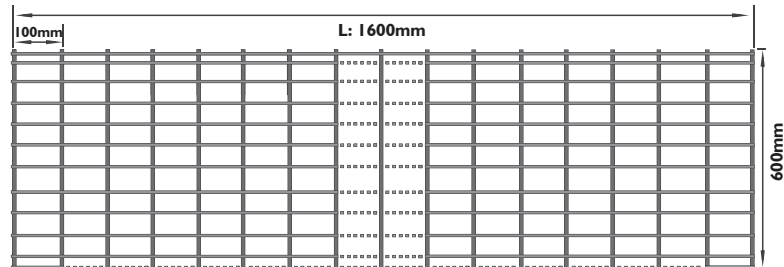
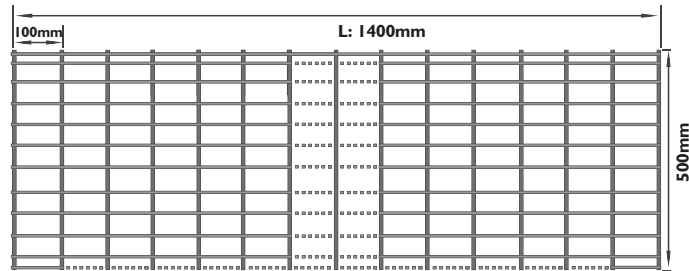
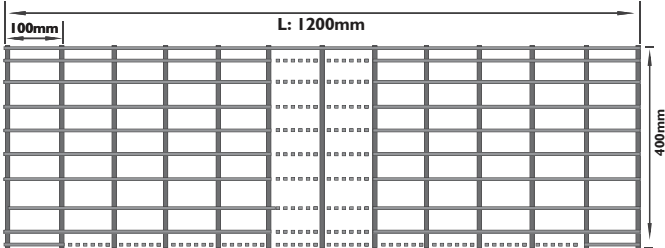
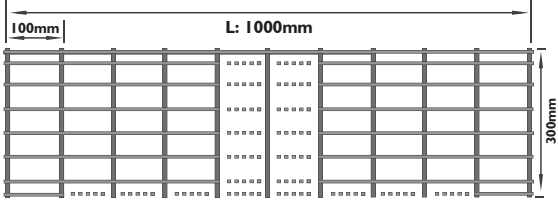
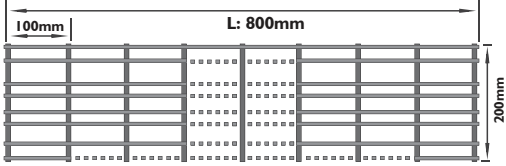
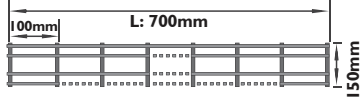
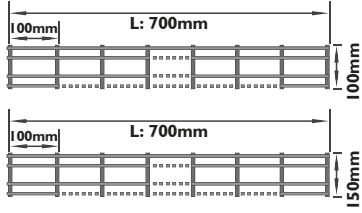
TKS

Radüslü Yatay 90° Dönüşler / 90° Bend

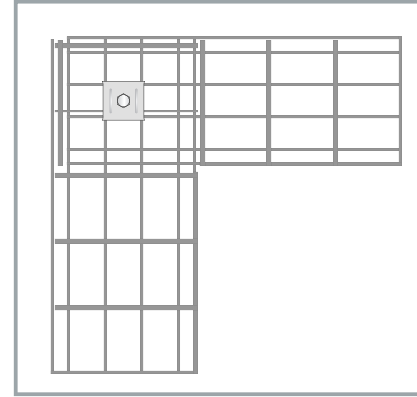
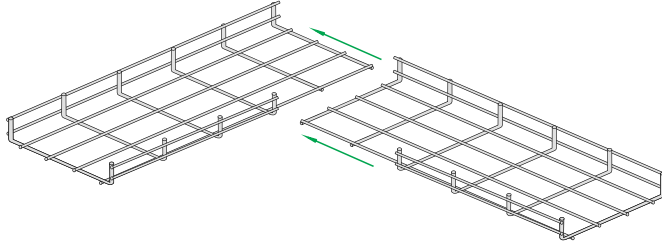

T Dönüşler / Tee Branches

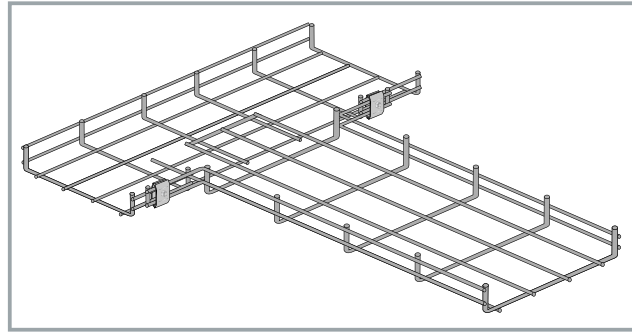
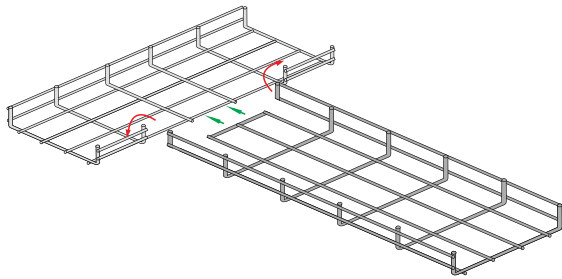

Ek Elemanı / Joint Pieces

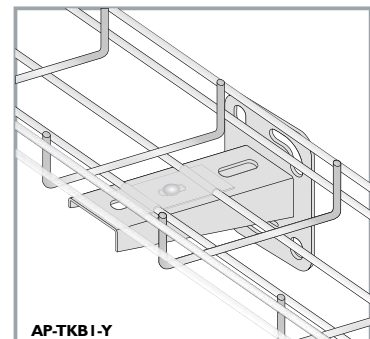
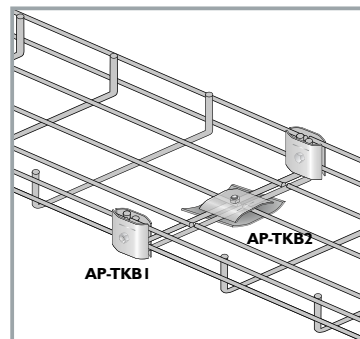
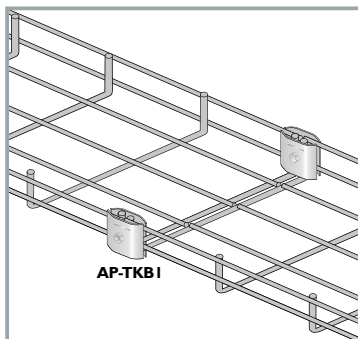
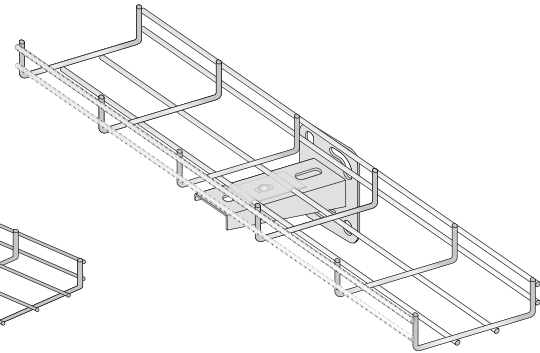
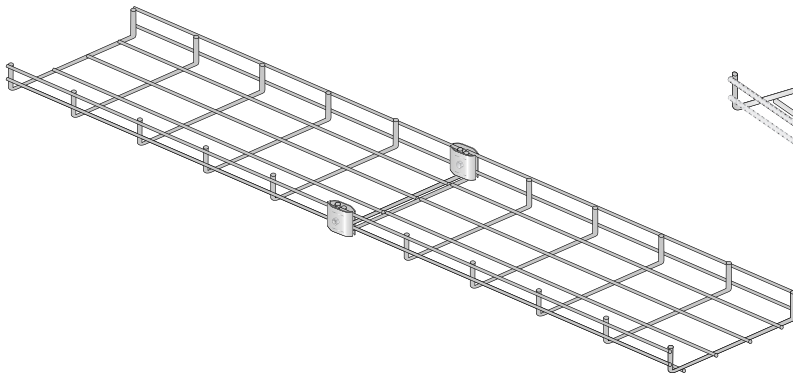

TKS