

NTK Normal Tip Kablo Kanalları Normal Type Cable Trays

A P E X M E T A L C A B L E T R A Y S Y S T E M S

NTK Serisi / Serie

ve Aksesuarlar
and Accessories



NTK Normal Tip Kablo Kanalları

Normal Type Cable Trays

Kategoriler Categories	Sayfa No Page No	İNDEKS / INDEX
h:40	NTK 01	Normal Tip Kablo Kanalı ve Ek Elemanı / <i>Normal Type Cable Trays and Joint Pieces</i>
	NTK 02	Normal Tip Dönüş Elemanları Yatay 90° -T Dönüş - Dörtlü Dönüş / <i>Horizontal Bends Bends 90° -Tee Branches - Crossing</i>
	NTK 03	Normal Tip Dönüş Elemanları Radüs 300 / <i>Horizontal Bends Radius 300</i>
	NTK 04	Normal Tip Dönüş Elemanları Radüs 450 / <i>Horizontal Bends Radius 450</i>
	NTK 05	Normal Tip Dönüş Elemanları Radüs 600 / <i>Horizontal Bends Radius 600</i>
	NTK 06	Normal Tip Dönüş Elemanları 135° - İç-Dış Bükey / <i>Normal Type 135°Bends - Vertical Inside and Outside Bends</i>
	NTK 07	Z Tip Redüksiyon Sol-Sağ-Ortadan / <i>Z Type Reducer Left-Right-Center</i>
h:50	NTK 08	Normal Tip Kablo Kanalı ve Ek Elemanı / <i>Normal Type Cable Trays and Joint Pieces</i>
	NTK 09	Normal Tip Dönüş Elemanları Yatay 90° -T Dönüş - Dörtlü Dönüş / <i>Horizontal Bends Bends 90° -Tee Branches - Crossing</i>
	NTK 10	Normal Tip Dönüş Elemanları Radüs 300 / <i>Horizontal Bends Radius 300</i>
	NTK 11	Normal Tip Dönüş Elemanları Radüs 450 / <i>Horizontal Bends Radius 450</i>
	NTK 12	Normal Tip Dönüş Elemanları Radüs 600 / <i>Horizontal Bends Radius 600</i>
	NTK 13	Normal Tip Dönüş Elemanları 135° - İç-Dış Bükey / <i>Normal Type 135°Bends - Vertical Inside and Outside Bends</i>
	NTK 14	Z Tip Redüksiyon Sol-Sağ-Ortadan / <i>Z Type Reducer Left-Right-Center</i>
h:60	NTK 15	Normal Tip Kablo Kanalı ve Ek Elemanı / <i>Normal Type Cable Trays and Joint Pieces</i>
	NTK 16	Normal Tip Dönüş Elemanları Yatay 90° -T Dönüş - Dörtlü Dönüş / <i>Horizontal Bends Bends 90° -Tee Branches - Crossing</i>
	NTK 17	Normal Tip Dönüş Elemanları Radüs 300 / <i>Horizontal Bends Radius 300</i>
	NTK 18	Normal Tip Dönüş Elemanları Radüs 450 / <i>Horizontal Bends Radius 450</i>
	NTK 19	Normal Tip Dönüş Elemanları Radüs 600 / <i>Horizontal Bends Radius 600</i>
	NTK 20	Normal Tip Dönüş Elemanları 135° - İç-Dış Bükey / <i>Normal Type 135°Bends - Vertical Inside and Outside Bends</i>
	NTK 21	Z Tip Redüksiyon Sol-Sağ-Ortadan / <i>Z Type Reducer Left-Right-Center</i>

NTK SERİSİ / SERIE

EN 61537

NTK Serisi / Serie

Sipariş Kodu (Order Code)	w (mm)	h (mm)	t (mm)	Kg/Mt (Kg/Mt)
AP-05.08	50	40	0,80	0,779
AP-05.10	50	40	1,00	0,973
AP-05.12	50	40	1,20	1,168
AP-05.15	50	40	1,50	1,460
AP-05.20	50	40	2,00	1,751
AP-07.08	70	40	0,80	0,904
AP-07.10	70	40	1,00	1,130
AP-07.12	70	40	1,20	1,356
AP-07.15	70	40	1,50	1,696
AP-07.20	70	40	2,00	2,034
AP-10.08	100	40	0,80	1,093
AP-10.10	100	40	1,00	1,366
AP-10.12	100	40	1,20	1,639
AP-10.15	100	40	1,50	2,049
AP-10.20	100	40	2,00	2,459
AP-12.08	120	40	0,80	1,218
AP-12.10	120	40	1,00	1,523
AP-12.12	120	40	1,20	1,827
AP-12.15	120	40	1,50	2,284
AP-12.20	120	40	2,00	2,741
AP-15.08	150	40	0,80	1,470
AP-15.10	150	40	1,00	1,758
AP-15.12	150	40	1,20	2,110
AP-15.15	150	40	1,50	2,638
AP-15.20	150	40	2,00	3,164
AP-20.08	200	40	0,80	1,721
AP-20.10	200	40	1,00	2,151
AP-20.12	200	40	1,20	2,581
AP-20.15	200	40	1,50	3,222
AP-20.20	200	40	2,00	3,872
AP-25.12	250	40	1,20	3,052
AP-25.15	250	40	1,50	3,815
AP-25.20	250	40	2,00	4,578
AP-30.12	300	40	1,20	3,523
AP-30.15	300	40	1,50	4,404
AP-30.20	300	40	2,00	5,285
AP-40.15	400	40	1,50	5,581
AP-40.20	400	40	2,00	6,698
AP-50.15	500	40	1,50	6,759
AP-50.20	500	40	2,00	8,111
AP-60.15	600	40	1,50	7,936
AP-60.20	600	40	2,00	9,524

Sipariş Kodu (Order Code)	w (mm)	h (mm)	t (mm)	L (mm)	Kg/Adet (Kg/Pcs.)
AP-KNI-04.12	15	42	1,20	174	0,093

NORMAL TİP KABLO KANALLARI
NORMAL TYPE CABLE TRAYS

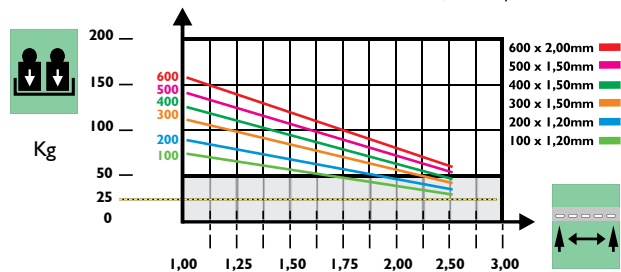
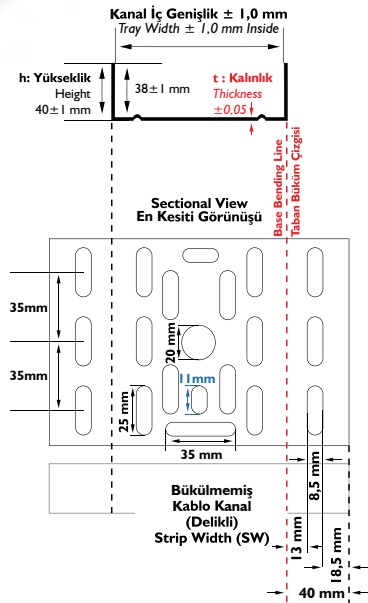
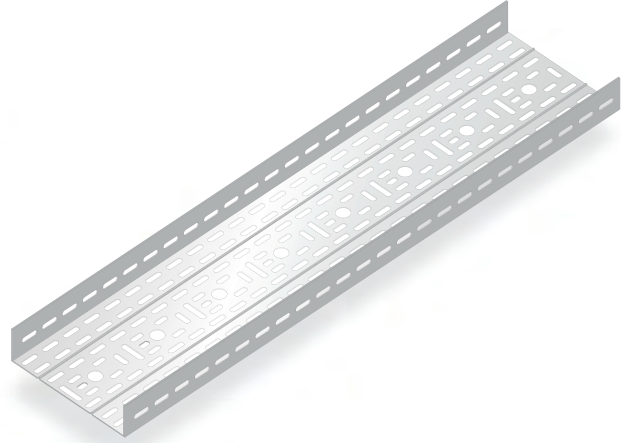

'm' Destekler Arası Mesafe
'm' Span Between Supports

Kilogram Olarak Müsade
Edilen Kablo Kanalı Yüğü
Cable Tray Load in Kg

EK ELEMANI
JOINT PIECE

► AÇIKLAMALAR / INSTRUCTIONS :

NOT: Ölçü toleransı ± 3 mm.'dir.

! Belirtilen ağırlıklar kesim ağırlıklarıdır.

! Metrik 8 cıvata ve somun kullanımına uygundur.

NOTE: The dimension tolerance in perforated cable trays is ± 3 mm

! The indicated weights are the weights before fabrication.

! Convenient for M8 bolt and nut usage.

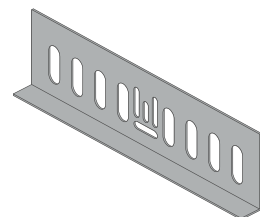
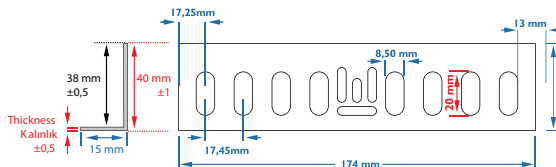

Sipariş Kodu (Order Code)	a, b (mm)	h (mm)	t (mm)	Kg/Adet (Kg/Pcs.)
AP-YDI05	55	41	1,20	0,366
AP-YDI07	75	41	1,20	0,404
AP-YDI10	105	41	1,20	0,647
AP-YDI12	125	41	1,20	0,809
AP-YDI15	155	41	1,20	0,917
AP-YDI20	205	41	1,20	1,235
AP-YDI25	255	41	1,20	1,599
AP-YDI30	305	41	1,50	2,514
AP-YDI40	405	41	1,50	3,719
AP-YDI50	505	41	1,50	5,161
AP-YDI60	605	41	1,50	6,838

➤ **AÇIKLAMALAR / INSTRUCTIONS :**

NOT: DÖNÜŞ MODÜLLERİNDEKİ ÖZEL UYGULAMALAR İÇİN ÖRNEK SİPARİŞ h:40mm a:100mm b:200mm "90° Yatay Dönüş"

NOTE: The example order for special applications in bend modules.
h:40mm. a:100mm b:200mm Bend 90°.

Sipariş Kodu (Order Code)	a, b, c (mm)	h (mm)	t (mm)	Kg/Adet (Kg/Pcs.)
AP-TD205	55	41	1,20	0,486
AP-TD207	75	41	1,20	0,530
AP-TD210	105	41	1,20	0,835
AP-TD212	125	41	1,20	0,972
AP-TD215	155	41	1,20	1,141
AP-TD220	205	41	1,20	1,494
AP-TD225	255	41	1,20	1,894
AP-TD230	305	41	1,50	2,928
AP-TD240	405	41	1,50	4,222
AP-TD250	505	41	1,50	5,753
AP-TD260	605	41	1,50	7,519

➤➤ **AÇIKLAMALAR / INSTRUCTIONS :**

NOT: DÖNÜŞ MODÜLLERİNDEKİ ÖZEL UYGULAMALAR İÇİN ÖRNEK SİPARİŞ h:40mm a:300mm b:200mm c:300mm "T" DÖNÜŞ

NOTE: The example order for special applications in bend modules.
h:40mm. a:100mm b:200mm c:300mm "Tee branch".

Sipariş Kodu (Order Code)	a, b, c, d (mm)	h (mm)	t (mm)	Kg/Adet (Kg/Pcs.)
AP-DD305	55	41	1,20	0,647
AP-DD307	75	41	1,20	0,697
AP-DD310	105	41	1,20	1,077
AP-DD312	125	41	1,20	1,214
AP-DD315	155	41	1,20	1,419
AP-DD320	205	41	1,20	1,775
AP-DD325	255	41	1,20	2,244
AP-DD330	305	41	1,50	3,409
AP-DD340	405	41	1,50	4,793
AP-DD350	505	41	1,50	6,414
AP-DD360	605	41	1,50	8,269

➤➤➤ **AÇIKLAMALAR / INSTRUCTIONS :**

NOT: DÖNÜŞ MODÜLLERİNDEKİ ÖZEL UYGULAMALAR İÇİN ÖRNEK SİPARİŞ h:40mm a:300mm b:200mm c:300mm d:200mm "Dörtlü" DÖNÜŞ

NOTE: The example order for special applications in bend modules.
h:40mm. a:100mm b:200mm c:300mm d:200mm "crossing"

NORMAL TİP 90° DÖNÜŞ ELEMANLARI
NORMAL TYPE 90° BENDS

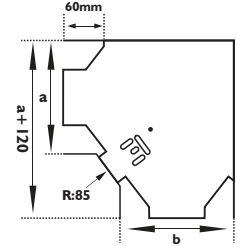
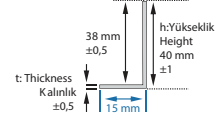
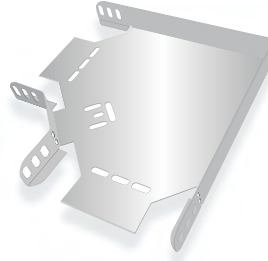

NORMAL TİP T DÖNÜŞ ELEMANLARI
NORMAL TYPE TEE-BRANCHES

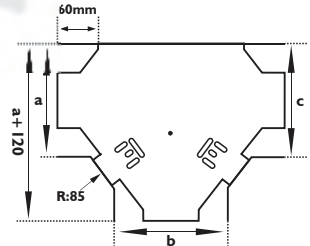
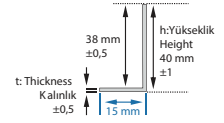
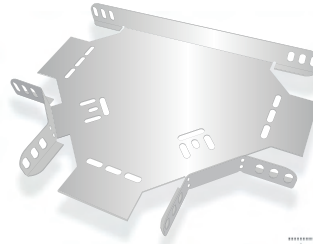

NORMAL TİP DÖRTLÜ BAĞLANTILAR
NORMAL TYPE CROSSINGS

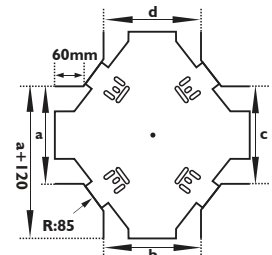
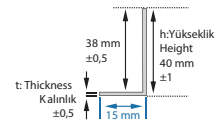
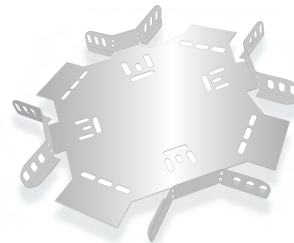

AÇIKLAMALAR / INSTRUCTIONS : Ekstra / Extra

Tüm dönüş uygulamaları, Metrik 8 civata ve somun kullanımına uygundur. Belirtilen ağırlıklar kesim ağırlıklarıdır.

All the bend implementation are convenient for M8 bolt and Nut usage. The indicated weights are the weights before fabrication.

Sipariş Kodu (Order Code)	a, b (mm)	h (mm)	t (mm)	Kg/Adet (Kg/Pcs.)
AP-YDI05/300	55	41	1,50	0,907
AP-YDI07/300	75	41	1,50	1,007
AP-YDI10/300	105	41	1,50	1,187
AP-YDI12/300	125	41	1,50	1,315
AP-YDI15/300	155	41	1,50	1,516
AP-YDI20/300	205	41	1,50	1,894
AP-YDI25/300	255	41	1,50	2,283
AP-YDI30/300	305	41	2,00	3,361
AP-YDI40/300	405	41	2,00	4,687
AP-YDI50/300	505	41	2,00	6,231
AP-YDI60/300	605	41	2,00	7,459

AÇIKLAMALAR / INSTRUCTIONS :

NOT: DÖNÜŞ MODÜLLERİNDEKİ ÖZEL UYGULAMALAR İÇİN ÖRNEK SİPARİŞ h:40mm a:100mm b:200mm "90° Yatay Dönüş"

NOTE: The example order for special applications in bend modules. h:40mm. a:100mm b:200mm Bend 90°.

Sipariş Kodu (Order Code)	a, b, c (mm)	h (mm)	t (mm)	Kg/Adet (Kg/Pcs.)
AP-TD205/300	55	41	1,50	2,204
AP-TD207/300	75	41	1,50	2,356
AP-TD210/300	105	41	1,50	2,592
AP-TD212/300	125	41	1,50	2,754
AP-TD215/300	155	41	1,50	3,440
AP-TD220/300	205	41	1,50	3,564
AP-TD225/300	255	41	1,50	4,581
AP-TD230/300	305	41	2,00	5,267
AP-TD240/300	405	41	2,00	6,531
AP-TD250/300	505	41	2,00	7,889
AP-TD260/300	605	41	2,00	8,813

AÇIKLAMALAR / INSTRUCTIONS :

NOT: DÖNÜŞ MODÜLLERİNDEKİ ÖZEL UYGULAMALAR İÇİN ÖRNEK SİPARİŞ h:40mm a:300mm b:200mm c:300mm "T" DÖNÜŞ

NOTE: The example order for special applications in bend modules. h:40mm. a:100mm b:200mm c:300mm "Tee branch".

Sipariş Kodu (Order Code)	a, b, c, d (mm)	h (mm)	t (mm)	Kg/Adet (Kg/Pcs.)
AP-DD305/300	55	41	1,50	2,561
AP-DD307/300	75	41	1,50	2,715
AP-DD310/300	105	41	1,50	3,078
AP-DD312/300	125	41	1,50	3,301
AP-DD315/300	155	41	1,50	3,653
AP-DD320/300	205	41	1,50	4,288
AP-DD325/300	255	41	1,50	4,982
AP-DD330/300	305	41	2,00	6,881
AP-DD340/300	405	41	2,00	8,899
AP-DD350/300	505	41	2,00	11,199
AP-DD360/300	605	41	2,00	13,782

AÇIKLAMALAR / INSTRUCTIONS :

NOT: DÖNÜŞ MODÜLLERİNDEKİ ÖZEL UYGULAMALAR İÇİN ÖRNEK SİPARİŞ h:40mm a:300mm b:200mm c:300mm d:200mm "Dörtlü" DÖNÜŞ

NOTE: The example order for special applications in bend modules. h:40mm. a:100mm b:200mm c:300mm d:200mm "crossing"

RADUS 300

NORMAL TİP 90° DÖNÜŞ ELEMANLARI
NORMAL TYPE 90° BENDS

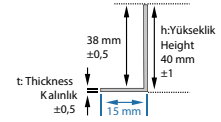
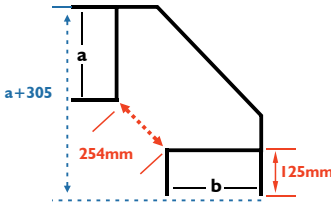
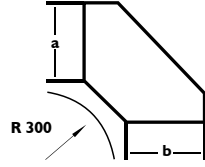

RADUS 300

NORMAL TİP T DÖNÜŞ ELEMANLARI
NORMAL TYPE TEE-BRANCHES

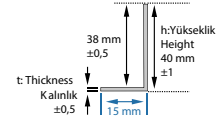
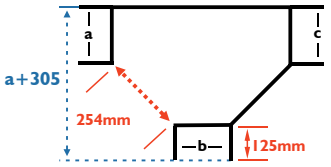
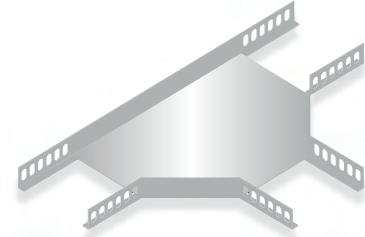
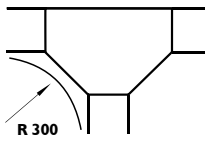

RADUS 300

NORMAL TİP DÖRTLÜ BAĞLANTILAR
NORMAL TYPE CROSSINGS

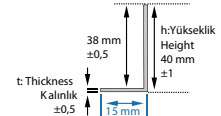
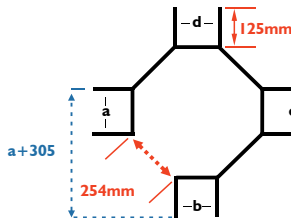
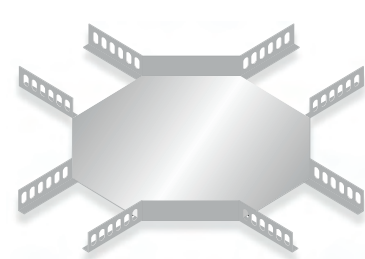
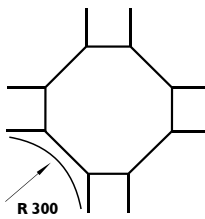

AÇIKLAMALAR / INSTRUCTIONS : Ekstra / Extra

Tüm dönüş uygulamaları, Metrik 8 civata ve somun kullanımına uygundur. Belirtilen ağırlıklar kesim ağırlıklarıdır.

All the bend implementation are convenient for M8 bolt and Nut usage. The indicated weights are the weights before fabrication.

Sipariş Kodu (Order Code)	a, b (mm)	h (mm)	t (mm)	Kg/Adet (Kg/Pcs.)
AP-YD105/450	55	41	1,50	1,058
AP-YD107/450	75	41	1,50	1,186
AP-YD110/450	105	41	1,50	1,408
AP-YD112/450	125	41	1,50	1,563
AP-YD115/450	155	41	1,50	1,805
AP-YD120/450	205	41	1,50	2,252
AP-YD125/450	255	41	1,50	2,710
AP-YD130/450	305	41	2,00	3,956
AP-YD140/450	405	41	2,00	5,448
AP-YD150/450	505	41	2,00	7,156
AP-YD160/450	605	41	2,00	8,550

► AÇIKLAMALAR / INSTRUCTIONS :

NOT: DÖNÜŞ MODÜLLERİNDEKİ ÖZEL UYGULAMALAR İÇİN ÖRNEK SİPARİŞ h:40mm a:100mm b:200mm "90° Yatay Dönüş"

NOTE: The example order for special applications in bend modules.
h:40mm. a:100mm b:200mm Bend 90°.

Sipariş Kodu (Order Code)	a, b, c (mm)	h (mm)	t (mm)	Kg/Adet (Kg/Pcs.)
AP-TD205/450	55	41	1,50	3,331
AP-TD207/450	75	41	1,50	3,541
AP-TD210/450	105	41	1,50	3,865
AP-TD212/450	125	41	1,50	4,086
AP-TD215/450	155	41	1,50	5,006
AP-TD220/450	205	41	1,50	5,129
AP-TD225/450	255	41	1,50	6,439
AP-TD230/450	305	41	2,00	7,496
AP-TD240/450	405	41	2,00	9,111
AP-TD250/450	505	41	2,00	10,819
AP-TD260/450	605	41	2,00	12,093

►► AÇIKLAMALAR / INSTRUCTIONS :

NOT: DÖNÜŞ MODÜLLERİNDEKİ ÖZEL UYGULAMALAR İÇİN ÖRNEK SİPARİŞ h:40mm a:300mm b:200mm c:300mm "T" DÖNÜŞ

NOTE: The example order for special applications in bend modules.
h:40mm. a:100mm b:200mm c:300mm "Tee branch".

Sipariş Kodu (Order Code)	a, b, c, d (mm)	h (mm)	t (mm)	Kg/Adet (Kg/Pcs.)
AP-DD305/450	55	41	1,50	3,940
AP-DD307/450	75	41	1,50	4,217
AP-DD310/450	105	41	1,50	4,651
AP-DD312/450	125	41	1,50	4,952
AP-DD315/450	155	41	1,50	5,421
AP-DD320/450	205	41	1,50	6,250
AP-DD325/450	255	41	1,50	7,138
AP-DD330/450	305	41	2,00	9,701
AP-DD340/450	405	41	2,00	12,185
AP-DD350/450	505	41	2,00	14,952
AP-DD360/450	605	41	2,00	18,001

►►► AÇIKLAMALAR / INSTRUCTIONS :

NOT: DÖNÜŞ MODÜLLERİNDEKİ ÖZEL UYGULAMALAR İÇİN ÖRNEK SİPARİŞ h:40mm a:300mm b:200mm c:300mm d:200mm "Dörtlü" DÖNÜŞ

NOTE: The example order for special applications in bend modules.
h:40mm. a:100mm b:200mm c:300mm d:200mm "crossing"

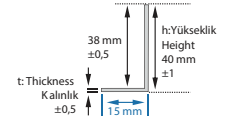
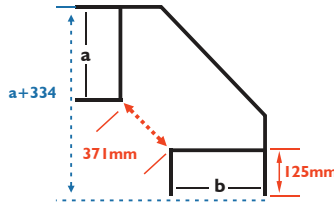
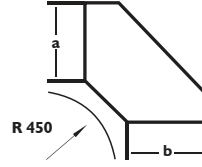
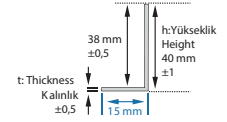
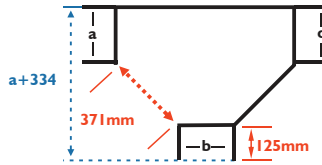
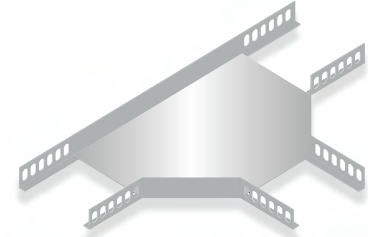
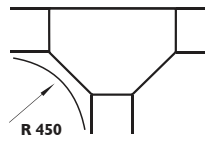
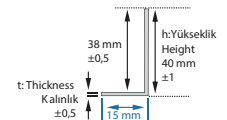
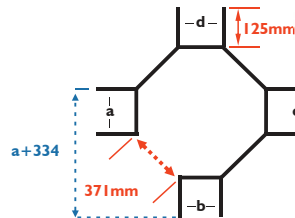
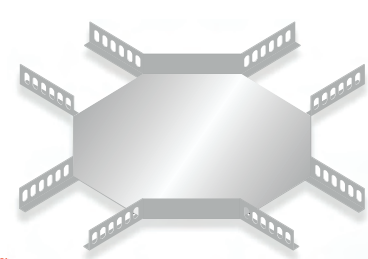
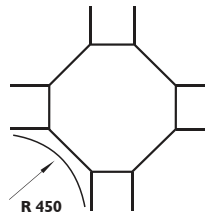
RADUS 450
NORMAL TİP 90° DÖNÜŞ ELEMANLARI
 NORMAL TYPE 90° BENDS

RADUS 450
NORMAL TİP T DÖNÜŞ ELEMANLARI
 NORMAL TYPE TEE-BRANCHES

RADUS 450
NORMAL TİP DÖRTLÜ BAĞLANTILAR
 NORMAL TYPE CROSSINGS

AÇIKLAMALAR / INSTRUCTIONS : Ekstra / Extra

Tüm dönüş uygulamaları, Metrik 8 civata ve somun kullanımına uygundur. Belirtilen ağırlıklar kesim ağırlıklarıdır.

All the bend implementation are convenient for M8 bolt and Nut usage. The indicated weights are the weights before fabrication.

NORMAL TİP YATAY DÖNÜŞ ELEMANLARI

NORMAL TYPE HORIZONTAL BENDS

info@apexelektrik.com



NORMAL
TİP KABLO
KANALLARI

Sipariş Kodu (Order Code)	a, b (mm)	h (mm)	t (mm)	Kg/Adet (Kg/Pcs.)
AP-YDI05/600	55	41	1,50	1,222
AP-YDI07/600	75	41	1,50	1,379
AP-YDI10/600	105	41	1,50	1,645
AP-YDI12/600	125	41	1,50	1,830
AP-YDI15/600	155	41	1,50	2,100
AP-YDI20/600	205	41	1,50	2,611
AP-YDI25/600	255	41	1,50	3,143
AP-YDI30/600	305	41	2,00	4,565
AP-YDI40/600	405	41	2,00	6,202
AP-YDI50/600	505	41	2,00	8,089
AP-YDI60/600	605	41	2,00	9,660

► AÇIKLAMALAR / INSTRUCTIONS :

NOT: DÖNÜŞ MODÜLLERİNDEKİ ÖZEL UYGULAMALAR İÇİN ÖRNEK
SİPARİŞ h:40mm a:100mm b:200mm "90° Yatay Dönüş"

NOTE: The example order for special applications in bend modules.
h:40mm. a:100mm b:200mm Bend 90°.

RADUS 600

NORMAL TİP 90° DÖNÜŞ ELEMANLARI

NORMAL TYPE 90° BENDS

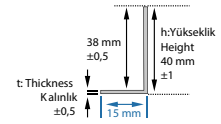
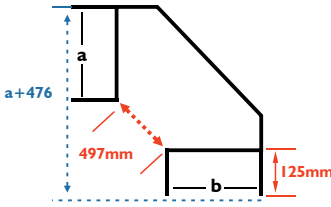
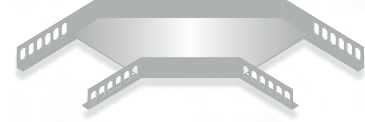
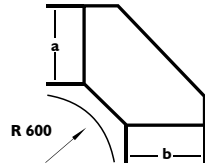

Sipariş Kodu (Order Code)	a, b, c (mm)	h (mm)	t (mm)	Kg/Adet (Kg/Pcs.)
AP-TD205/600	55	41	1,50	4,850
AP-TD207/600	75	41	1,50	5,122
AP-TD210/600	105	41	1,50	5,538
AP-TD212/600	125	41	1,50	5,821
AP-TD215/600	155	41	1,50	6,986
AP-TD220/600	205	41	1,50	7,110
AP-TD225/600	255	41	1,50	8,726
AP-TD230/600	305	41	2,00	10,241
AP-TD240/600	405	41	2,00	12,225
AP-TD250/600	505	41	2,00	14,302
AP-TD260/600	605	41	2,00	15,945

►► AÇIKLAMALAR / INSTRUCTIONS :

NOT: DÖNÜŞ MODÜLLERİNDEKİ ÖZEL UYGULAMALAR İÇİN ÖRNEK
SİPARİŞ h:40mm a:300mm b:200mm c:300mm "T" DÖNÜŞ

NOTE: The example order for special applications in bend modules.
h:40mm. a:100mm b:200mm c:300mm "Tee branch".

RADUS 600

NORMAL TİP T DÖNÜŞ ELEMANLARI

NORMAL TYPE TEE-BRANCHES

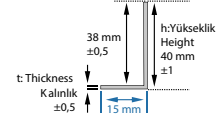
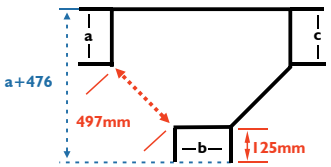
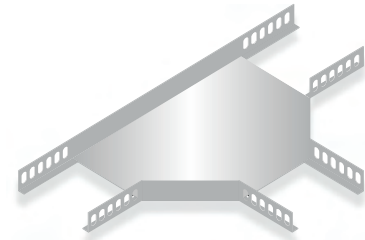
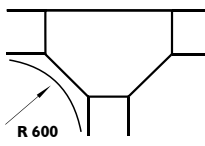

Sipariş Kodu (Order Code)	a, b, c, d (mm)	h (mm)	t (mm)	Kg/Adet (Kg/Pcs.)
AP-DD305/600	55	41	1,50	5,799
AP-DD307/600	75	41	1,50	6,161
AP-DD310/600	105	41	1,50	6,721
AP-DD312/600	125	41	1,50	7,106
AP-DD315/600	155	41	1,50	7,702
AP-DD320/600	205	41	1,50	8,742
AP-DD325/600	255	41	1,50	9,840
AP-DD330/600	305	41	2,00	13,197
AP-DD340/600	405	41	2,00	16,187
AP-DD350/600	505	41	2,00	19,460
AP-DD360/600	605	41	2,00	23,015

►►► AÇIKLAMALAR / INSTRUCTIONS :

NOT: DÖNÜŞ MODÜLLERİNDEKİ ÖZEL UYGULAMALAR İÇİN ÖRNEK
SİPARİŞ h:40mm a:300mm b:200mm c:300mm d:200mm "Dörtlü" DÖNÜŞ

NOTE: The example order for special applications in bend modules.
h:40mm. a:100mm b:200mm c:300mm d:200mm "crossing"

RADUS 600

NORMAL TİP DÖRTLÜ BAĞLANTILAR

NORMAL TYPE CROSSINGS

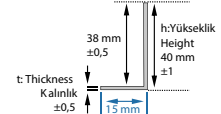
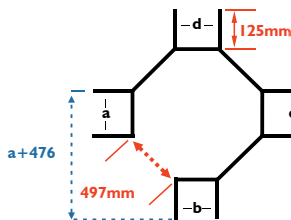
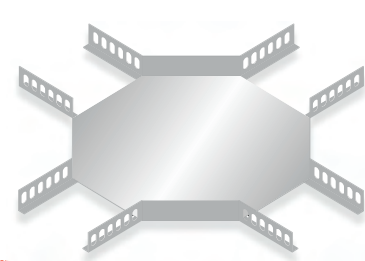
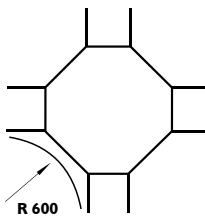

AÇIKLAMALAR / INSTRUCTIONS : Ekstra / Extra

Tüm dönüş uygulamaları, Metrik 8 civata ve somun kullanımına uygundur.
Belirtilen ağırlıklar kesim ağırlıklarıdır.

All the bend implementation are convenient for M8 bolt and Nut usage.
The indicated weights are the weights before fabrication.

Sipariş Kodu (Order Code)	a (mm)	b (mm)	c (mm)	h (mm)	t (mm)	Kg/Adet (Kg/Pcs.)
AP-YD105/135	55	115	105	41	1,50	1,083
AP-YD107/135	75	135	115	41	1,50	1,174
AP-YD110/135	105	165	130	41	1,50	1,335
AP-YD112/135	125	185	140	41	1,50	1,463
AP-YD115/135	155	215	155	41	1,50	1,652
AP-YD120/135	205	265	180	41	1,50	1,851
AP-YD125/135	255	315	205	41	1,50	2,152
AP-YD130/135	305	365	230	41	2,00	2,897
AP-YD140/135	405	465	285	41	2,00	3,653
AP-YD150/135	505	565	335	41	2,00	4,469
AP-YD160/135	605	665	385	41	2,00	5,350

► AÇIKLAMALAR / INSTRUCTIONS :

NOT: Lütfen siparişlerinizde 135° dönüş tipini ve sipariş kodunu belirtiniz.

! Metrik 8 cıvata ve somun kullanımına uygundur. Belirtilen ağırlıklar kesim ağırlıklarıdır.

NOTE: Please indicate the 135° Bend type and order code.

! M8 bolt and Nut usage. The indicated weights are the weights before fabrication.

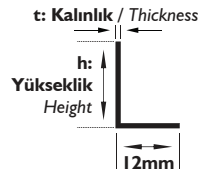

a: Genişlik / Width
b: Dış Kenar / Periphery
c: İç Kenar / Inner Edge

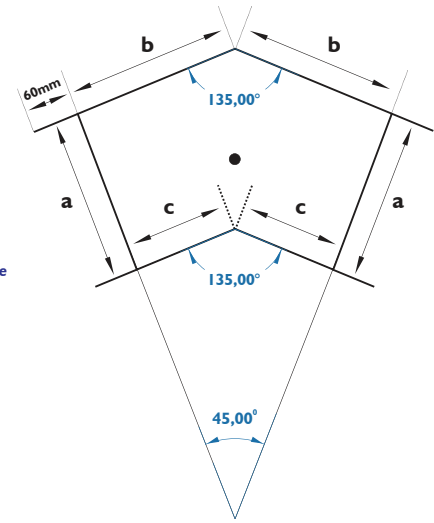
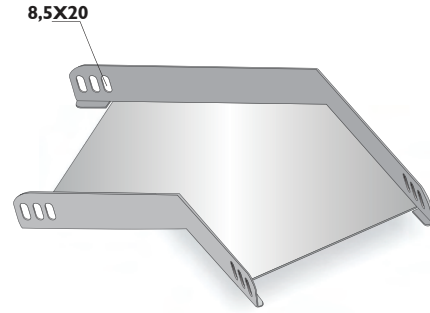
NORMAL TİP 135° DÖNÜŞ ELEMANLARI
 NORMAL TYPE 135° BENDS

Sipariş Kodu (Order Code)	w (mm)	h (mm)	t (mm)	Kg/Adet (Kg/Pcs.)
AP-B505	50	40	1,00	0,779
AP-B507	70	40	1,00	0,905
AP-B510	100	40	1,00	1,093
AP-B512	120	40	1,00	1,219
AP-B515	150	40	1,20	1,689
AP-B520	200	40	1,20	2,065
AP-B525	250	40	1,20	3,052
AP-B530	300	40	1,50	3,523
AP-B540	400	40	1,50	4,465
AP-B550	500	40	1,50	5,407
AP-B560	600	40	1,50	6,349

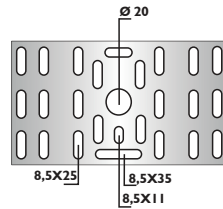
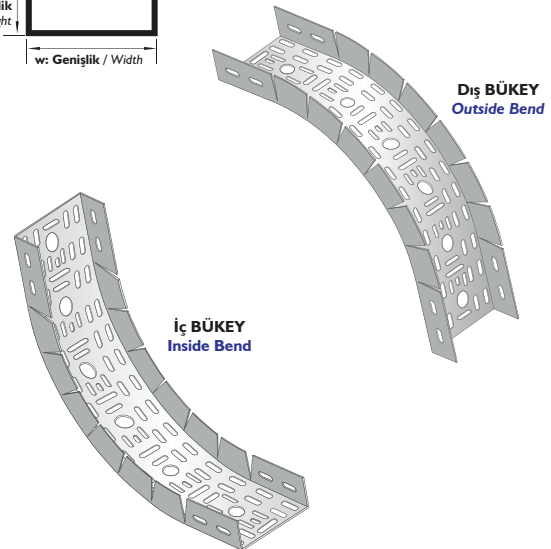
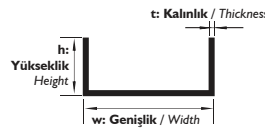
İÇ VE DIŞ BÜKEY ELEMANLARI
 VERTICAL INSIDE AND OUTSIDE BENDS

►► AÇIKLAMALAR / INSTRUCTIONS :

NOT: Lütfen siparişlerinizde bükey tipini ve sipariş kodunu belirtiniz.

! Standart uzunluk 800mm. İsteğe bağlı olarak uzunluklar değişebilir.

! Metrik 8 cıvata ve somun kullanımına uygundur. Belirtilen ağırlıklar kesim ağırlıklarıdır.

NOTE: Please indicate the vertical adjustable inside and outside bends type and order code.

! Standart Length is 800mm. On request the Lengths can change.

! M8 bolt and Nut usage. The indicated weights are the weights before fabrication.

Z TİPİ REDÜKSİYONLAR Z TYPE REDUCERS

info@apexelektrik.com

Sipariş Kodu (Order Code)	w (mm)	h (mm)	t (mm)	Kg/Takım (Kg/Set)
AP-RZI-50	50	40	1,50	0,173
AP-RZI-100	100	40	1,50	0,197
AP-RZI-150	150	40	1,50	0,220
AP-RZI-200	200	40	1,50	0,244
AP-RZI-250	250	40	1,50	0,267
AP-RZI-300	300	40	1,50	0,291

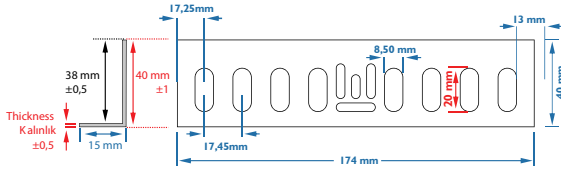

SOLA / LEFT

Z TİPİ REDÜKSİYONLAR SOLA Z TYPE REDUCERS LEFT

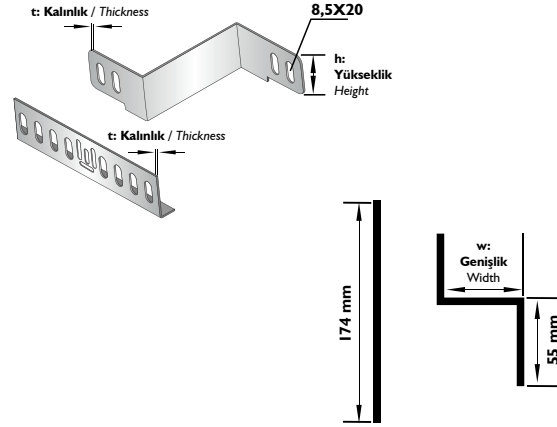

Sipariş Kodu (Order Code)	w (mm)	h (mm)	t (mm)	Kg/Takım (Kg/Set)
AP-RZI-50	50	40	1,50	0,173
AP-RZI-100	100	40	1,50	0,197
AP-RZI-150	150	40	1,50	0,220
AP-RZI-200	200	40	1,50	0,244
AP-RZI-250	250	40	1,50	0,267
AP-RZI-300	300	40	1,50	0,291

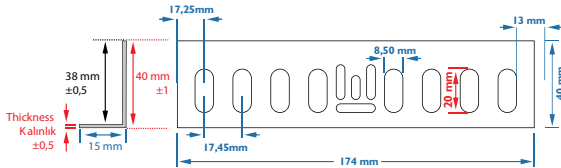

SAĞA / RIGHT

Z TİPİ REDÜKSİYONLAR SAĞA Z TYPE REDUCERS RIGHT

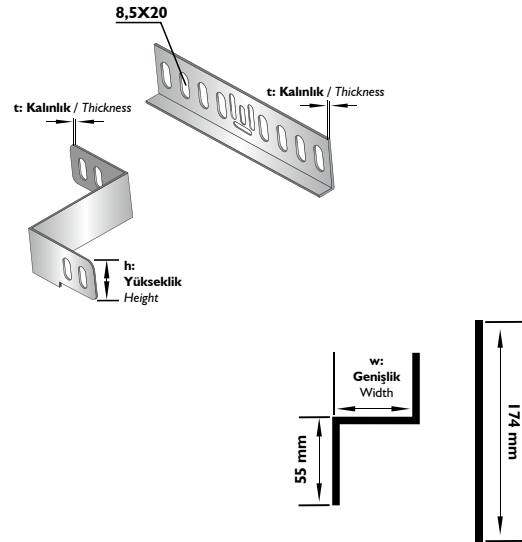

Sipariş Kodu (Order Code)	w (mm)	h (mm)	t (mm)	Kg/Takım (Kg/Set)
AP-RZ2-25	25	40	1,50	0,137
AP-RZ2-50	50	40	1,50	0,160
AP-RZ2-100	100	40	1,50	0,207
AP-RZ2-150	150	40	1,50	0,254
AP-RZ2-200	200	40	1,50	0,301
AP-RZ2-250	250	40	1,50	0,349

ORTADAN / CENTER

Z TİPİ REDÜKSİYONLAR ORTADAN Z TYPE REDUCERS CENTER

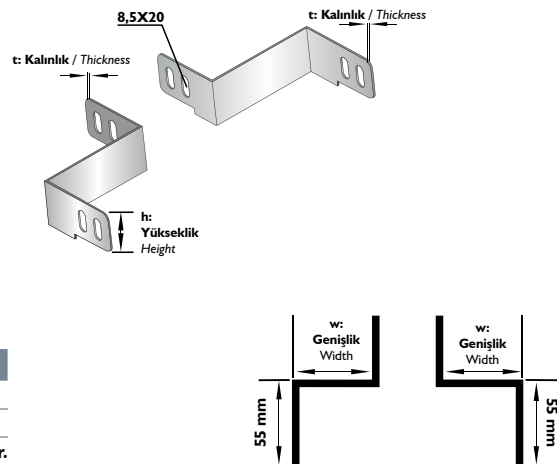

➤ AÇIKLAMALAR / INSTRUCTIONS :

NOT: Lütfen siparişlerinizde redüksiyon tipini ve "w" ölçüsünü belirtiniz.

! Özel ölçüler için lütfen 8mm ile ir tibata geçiniz.

! Metrik 8 cıvata ve somun kullanımına uygundur. Belirtilen ağırlıklar kesim ağırlıklarıdır.

NOTE: Please assert the reduction type and "w" dimension.

! For special dimensions please contact our 8mm

! M8 bolt and Nut usage. The indicated weights are the weights before fabrication.

Sipariş Kodu (Order Code)	w (mm)	h (mm)	t (mm)	Kg/Mt (Kg/Mt)
AP-05H.08	50	50	0,80	0,904
AP-05H.10	50	50	1,00	1,130
AP-05H.12	50	50	1,20	1,356
AP-05H.15	50	50	1,50	1,696
AP-05H.20	50	50	2,00	2,034
AP-07H.08	70	50	0,80	1,030
AP-07H.10	70	50	1,00	1,287
AP-07H.12	70	50	1,20	1,545
AP-07H.15	70	50	1,50	1,931
AP-07H.20	70	50	2,00	2,317
AP-10H.08	100	50	0,80	1,218
AP-10H.10	100	50	1,00	1,523
AP-10H.12	100	50	1,20	1,827
AP-10H.15	100	50	1,50	2,284
AP-10H.20	100	50	2,00	2,741
AP-12H.08	120	50	0,80	1,344
AP-12H.10	120	50	1,00	1,680
AP-12H.12	120	50	1,20	2,016
AP-12H.15	120	50	1,50	2,520
AP-12H.20	120	50	2,00	3,024
AP-15H.08	150	50	0,80	1,532
AP-15H.10	150	50	1,00	1,915
AP-15H.12	150	50	1,20	2,298
AP-15H.15	150	50	1,50	2,873
AP-15H.20	150	50	2,00	3,447
AP-20H.08	200	50	0,80	1,846
AP-20H.10	200	50	1,00	2,308
AP-20H.12	200	50	1,20	2,769
AP-20H.15	200	50	1,50	3,462
AP-20H.20	200	50	2,00	4,154
AP-25H.12	250	50	1,20	3,240
AP-25H.15	250	50	1,50	4,051
AP-25H.20	250	50	2,00	4,861
AP-30H.12	300	50	1,20	3,711
AP-30H.15	300	50	1,50	4,639
AP-30H.20	300	50	2,00	5,568
AP-40H.15	400	50	1,50	5,817
AP-40H.20	400	50	2,00	6,980
AP-50H.15	500	50	1,50	6,994
AP-50H.20	500	50	2,00	8,393
AP-60H.15	600	50	1,50	8,172
AP-60H.20	600	50	2,00	9,806

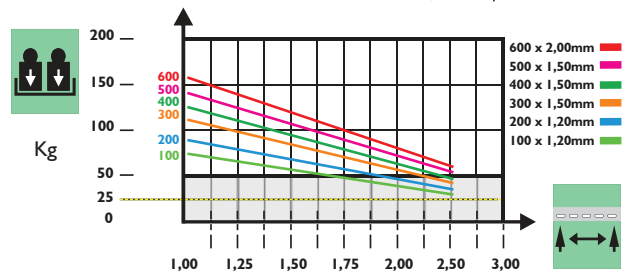
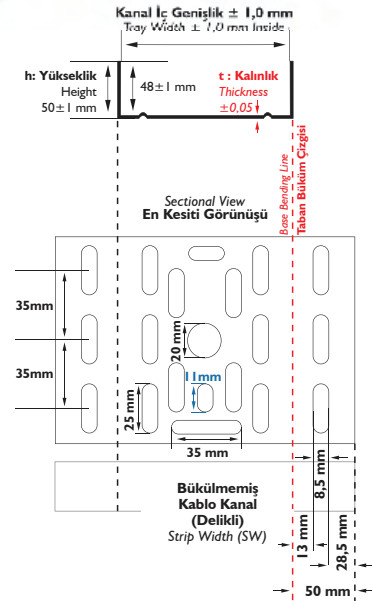
NORMAL TİP KABLO KANALLARI
 NORMAL TYPE CABLE TRAYS

'm' Destekler Arası Mesafe
'm' Span Between Supports

Kilogram Olarak Müsade
Edilen Kablo Kanalı Yüklü
Cable Tray Load in Kg

Sipariş Kodu (Order Code)	w (mm)	h (mm)	t (mm)	L (mm)	Kg/Adet (Kg/Pcs.)
AP-KNI-05.12	15	52	1,20	174	0,110

EK ELEMANI
 JOINT PIECE

AÇIKLAMALAR / INSTRUCTIONS :

NOT: Ölçü toleransı ± 3 mm.'dir.

! Belirtilen ağırlıklar kesim ağırlıktandır.

! Metrik 8 cıvata ve somun kullanımına uygundur.

NOTE: The dimension tolerance in perforated cable trays is ± 3 mm

! The indicated weights are the weights before fabrication.

! Convenient for M8 bolt and nut usage.

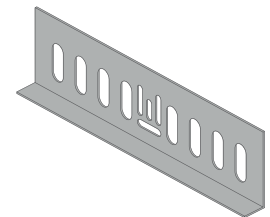
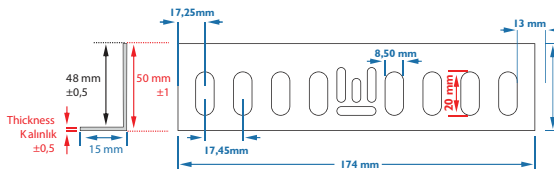

NORMAL TİP YATAY DÖNÜŞ ELEMANLARI

NORMAL TYPE HORIZONTAL BENDS

info@apexelektrik.com



NORMAL
TİP KABLO
KANALLARI

Sipariş Kodu (Order Code)	a, b (mm)	h (mm)	t (mm)	Kg/Adet (Kg/Pcs.)
AP-YDH105	55	51	1,20	0,404
AP-YDH107	75	51	1,20	0,444
AP-YDH110	105	51	1,20	0,697
AP-YDH112	125	51	1,20	0,809
AP-YDH115	155	51	1,20	0,977
AP-YDH120	205	51	1,20	1,304
AP-YDH125	255	51	1,20	1,678
AP-YDH130	305	51	1,50	2,624
AP-YDH140	405	51	1,50	3,853
AP-YDH150	505	51	1,50	5,318
AP-YDH160	605	51	1,50	7,018

► AÇIKLAMALAR / INSTRUCTIONS :

NOT: DÖNÜŞ MODÜLLERİNDEKİ ÖZEL UYGULAMALAR İÇİN ÖRNEK
SİPARİŞ h:40mm a:100mm b:200mm "90° Yatay Dönüş"

NOTE: The example order for special applications in bend modules.
h:40mm. a:100mm b:200mm Bend 90°.

Sipariş Kodu (Order Code)	a, b, c (mm)	h (mm)	t (mm)	Kg/Adet (Kg/Pcs.)
AP-TDH205	55	51	1,20	0,530
AP-TDH207	75	51	1,20	0,576
AP-TDH210	105	51	1,20	0,867
AP-TDH212	125	51	1,20	0,991
AP-TDH215	155	51	1,20	1,177
AP-TDH220	205	51	1,20	1,535
AP-TDH225	255	51	1,20	1,939
AP-TDH230	305	51	1,50	2,990
AP-TDH240	405	51	1,50	4,298
AP-TDH250	505	51	1,50	5,839
AP-TDH260	605	51	1,50	7,618

►► AÇIKLAMALAR / INSTRUCTIONS :

NOT: DÖNÜŞ MODÜLLERİNDEKİ ÖZEL UYGULAMALAR İÇİN ÖRNEK
SİPARİŞ h:40mm a:300mm b:200mm c:300mm "T" DÖNÜŞ

NOTE: The example order for special applications in bend modules.
h:40mm. a:100mm b:200mm c:300mm "Tee branch".

Sipariş Kodu (Order Code)	a, b, c, d (mm)	h (mm)	t (mm)	Kg/Adet (Kg/Pcs.)
AP-DDH305	55	51	1,20	0,697
AP-DDH307	75	51	1,20	0,749
AP-DDH310	105	51	1,20	1,077
AP-DDH312	125	51	1,20	1,214
AP-DDH315	155	51	1,20	1,419
AP-DDH320	205	51	1,20	1,775
AP-DDH325	255	51	1,20	2,244
AP-DDH330	305	51	1,50	3,409
AP-DDH340	405	51	1,50	4,793
AP-DDH350	505	51	1,50	6,414
AP-DDH360	605	51	1,50	8,269

►►► AÇIKLAMALAR / INSTRUCTIONS :

NOT: DÖNÜŞ MODÜLLERİNDEKİ ÖZEL UYGULAMALAR İÇİN ÖRNEK
SİPARİŞ h:40mm a:300mm b:200mm c:300mm d:200mm "Dörtlü" DÖNÜŞ

NOTE: The example order for special applications in bend modules.
h:40mm. a:100mm b:200mm c:300mm d:200mm "crossing"

NORMAL TİP 90° DÖNÜŞ ELEMANLARI

NORMAL TYPE 90° BENDS

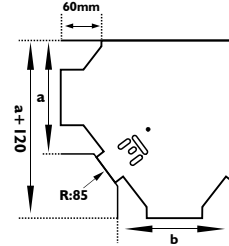
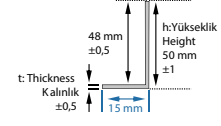
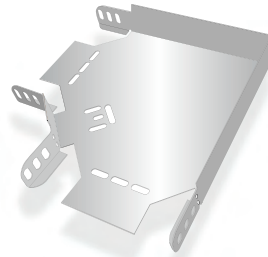

NORMAL TİP T DÖNÜŞ ELEMANLARI

NORMAL TYPE TEE-BRANCHES

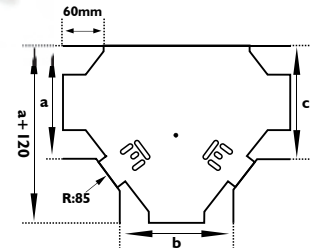
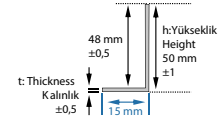
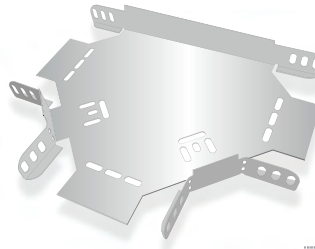

NORMAL TİP DÖRTLÜ BAĞLANTILAR

NORMAL TYPE CROSSINGS

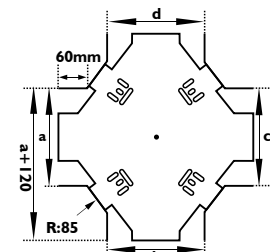
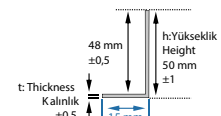
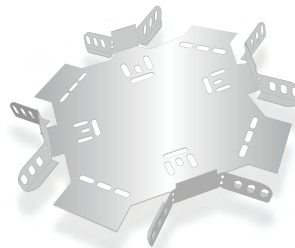

AÇIKLAMALAR / INSTRUCTIONS : Ekstra / Extra

Tüm dönüş uygulamaları, Metrik 8 civata ve somun kullanımına uygundur.
Belirtilen ağırlıklar kesim ağırlıklarıdır.

All the bend implementation are convenient for M8 bolt and Nut usage.
The indicated weights are the weights before fabrication.

Sipariş Kodu (Order Code)	a, b (mm)	h (mm)	t (mm)	Kg/Adet (Kg/Pcs.)
AP-YDH105/300	55	51	1,50	1,036
AP-YDH107/300	75	51	1,50	1,140
AP-YDH110/300	105	51	1,50	1,327
AP-YDH112/300	125	51	1,50	1,458
AP-YDH115/300	155	51	1,50	1,665
AP-YDH120/300	205	51	1,50	2,052
AP-YDH125/300	255	51	1,50	2,452
AP-YDH130/300	305	51	2,00	3,574
AP-YDH140/300	405	51	2,00	4,925
AP-YDH150/300	505	51	2,00	6,791
AP-YDH160/300	605	51	2,00	7,743

► AÇIKLAMALAR / INSTRUCTIONS :

NOT: DÖNÜŞ MODÜLLERİNDEKİ ÖZEL UYGULAMALAR İÇİN ÖRNEK SİPARİŞ h:40mm a:100mm b:200mm "90° Yatay Dönüş"

NOTE: The example order for special applications in bend modules. h:40mm. a:100mm b:200mm Bend 90°.

Sipariş Kodu (Order Code)	a, b, c (mm)	h (mm)	t (mm)	Kg/Adet (Kg/Pcs.)
AP-TDH205/300	55	51	1,50	2,400
AP-TDH207/300	75	51	1,50	2,555
AP-TDH210/300	105	51	1,50	2,795
AP-TDH212/300	125	51	1,50	2,959
AP-TDH215/300	155	51	1,50	3,655
AP-TDH220/300	205	51	1,50	3,778
AP-TDH225/300	255	51	1,50	4,808
AP-TDH230/300	305	51	2,00	5,539
AP-TDH240/300	405	51	2,00	6,817
AP-TDH250/300	505	51	2,00	8,189
AP-TDH260/300	605	51	2,00	9,127

►► AÇIKLAMALAR / INSTRUCTIONS :

NOT: DÖNÜŞ MODÜLLERİNDEKİ ÖZEL UYGULAMALAR İÇİN ÖRNEK SİPARİŞ h:40mm a:300mm b:200mm c:300mm "T" DÖNÜŞ

NOTE: The example order for special applications in bend modules. h:40mm. a:100mm b:200mm c:300mm "Tee branch".

Sipariş Kodu (Order Code)	a, b, c, d (mm)	h (mm)	t (mm)	Kg/Adet (Kg/Pcs.)
AP-DDH305/300	55	51	1,50	2,798
AP-DDH307/300	75	51	1,50	2,952
AP-DDH310/300	105	51	1,50	3,315
AP-DDH312/300	125	51	1,50	3,538
AP-DDH315/300	155	51	1,50	3,891
AP-DDH320/300	205	51	1,50	4,526
AP-DDH325/300	255	51	1,50	5,219
AP-DDH330/300	305	51	2,00	7,166
AP-DDH340/300	405	51	2,00	9,184
AP-DDH350/300	505	51	2,00	11,484
AP-DDH360/300	605	51	2,00	14,067

►►► AÇIKLAMALAR / INSTRUCTIONS :

NOT: DÖNÜŞ MODÜLLERİNDEKİ ÖZEL UYGULAMALAR İÇİN ÖRNEK SİPARİŞ h:40mm a:300mm b:200mm c:300mm d:200mm "Dörtlü" DÖNÜŞ

NOTE: The example order for special applications in bend modules. h:40mm. a:100mm b:200mm c:300mm d:200mm "crossing"

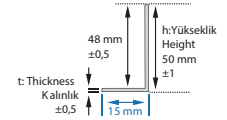
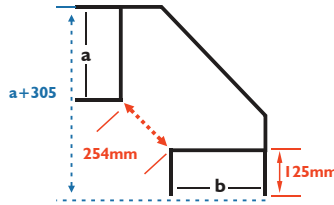
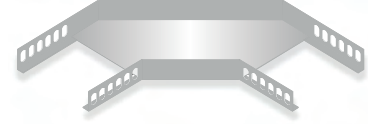
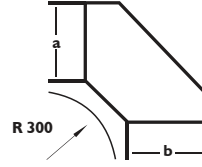
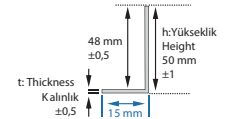
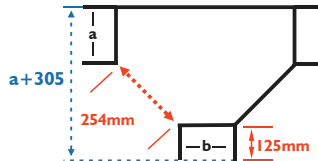
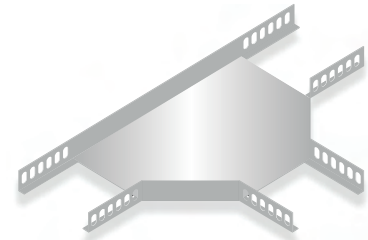
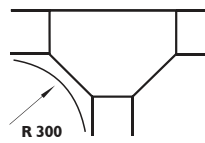
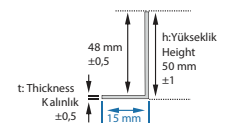
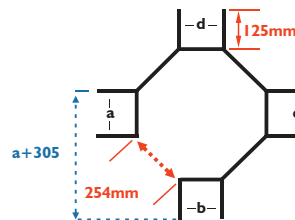
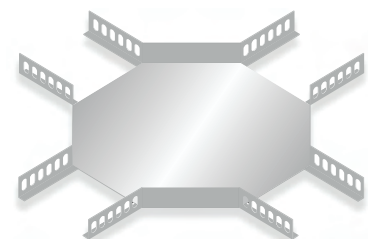
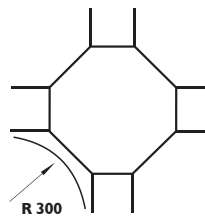
RADUS 300
NORMAL TİP 90° DÖNÜŞ ELEMANLARI
 NORMAL TYPE 90° BENDS

RADUS 300
NORMAL TİP T DÖNÜŞ ELEMANLARI
 NORMAL TYPE TEE-BRANCHES

RADUS 300
NORMAL TİP DÖRTLÜ BAĞLANTILAR
 NORMAL TYPE CROSSINGS

AÇIKLAMALAR / INSTRUCTIONS : Ekstra / Extra

Tüm dönüş uygulamaları, Metrik 8 civata ve somun kullanımına uygundur. Belirtilen ağırlıklar kesim ağırlıklarıdır.

All the bend implementation are convenient for M8 bolt and Nut usage. The indicated weights are the weights before fabrication.

Sipariş Kodu (Order Code)	a, b (mm)	h (mm)	t (mm)	Kg/Adet (Kg/Pcs.)
AP-YDHI05/450	55	51	1,50	1,202
AP-YDHI07/450	75	51	1,50	1,333
AP-YDHI10/450	105	51	1,50	1,561
AP-YDHI12/450	125	51	1,50	1,720
AP-YDHI15/450	155	51	1,50	1,968
AP-YDHI20/450	205	51	1,50	2,424
AP-YDHI25/450	255	51	1,50	2,893
AP-YDHI30/450	305	51	2,00	4,186
AP-YDHI40/450	405	51	2,00	5,702
AP-YDHI50/450	505	51	2,00	7,434
AP-YDHI60/450	605	51	2,00	8,850

► AÇIKLAMALAR / INSTRUCTIONS :

NOT: DÖNÜŞ MODÜLLERİNDEKİ ÖZEL UYGULAMALAR İÇİN ÖRNEK
SİPARİŞ h:40mm a:100mm b:200mm "90° Yatay Dönüş"

NOTE: The example order for special applications in bend modules.
h:40mm. a:100mm b:200mm Bend 90°.

Sipariş Kodu (Order Code)	a, b, c (mm)	h (mm)	t (mm)	Kg/Adet (Kg/Pcs.)
AP-TDH205/450	55	51	1,50	3,547
AP-TDH207/450	75	51	1,50	3,760
AP-TDH210/450	105	51	1,50	4,087
AP-TDH212/450	125	51	1,50	4,311
AP-TDH215/450	155	51	1,50	5,240
AP-TDH220/450	205	51	1,50	5,360
AP-TDH225/450	255	51	1,50	6,684
AP-TDH230/450	305	51	2,00	7,791
AP-TDH240/450	405	51	2,00	9,420
AP-TDH250/450	505	51	2,00	11,142
AP-TDH260/450	605	51	2,00	12,431

►► AÇIKLAMALAR / INSTRUCTIONS :

NOT: DÖNÜŞ MODÜLLERİNDEKİ ÖZEL UYGULAMALAR İÇİN ÖRNEK
SİPARİŞ h:40mm a:300mm b:200mm c:300mm "T" DÖNÜŞ

NOTE: The example order for special applications in bend modules.
h:40mm. a:100mm b:200mm c:300mm "Tee branch".

Sipariş Kodu (Order Code)	a, b, c, d (mm)	h (mm)	t (mm)	Kg/Adet (Kg/Pcs.)
AP-DDH305/450	55	51	1,50	4,232
AP-DDH307/450	75	51	1,50	4,510
AP-DDH310/450	105	51	1,50	4,943
AP-DDH312/450	125	51	1,50	5,244
AP-DDH315/450	155	51	1,50	5,713
AP-DDH320/450	205	51	1,50	6,542
AP-DDH325/450	255	51	1,50	7,430
AP-DDH330/450	305	51	2,00	10,052
AP-DDH340/450	405	51	2,00	12,536
AP-DDH350/450	505	51	2,00	15,303
AP-DDH360/450	605	51	2,00	18,352

►►► AÇIKLAMALAR / INSTRUCTIONS :

NOT: DÖNÜŞ MODÜLLERİNDEKİ ÖZEL UYGULAMALAR İÇİN ÖRNEK
SİPARİŞ h:40mm a:300mm b:200mm c:300mm d:200mm "Dörtlü" DÖNÜŞ

NOTE: The example order for special applications in bend modules.
h:40mm. a:100mm b:200mm c:300mm d:200mm "crossing"

RADUS 450

NORMAL TİP 90° DÖNÜŞ ELEMANLARI
NORMAL TYPE 90° BENDS

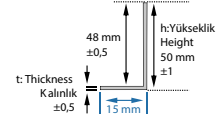
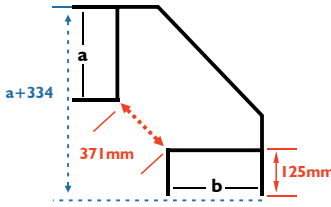
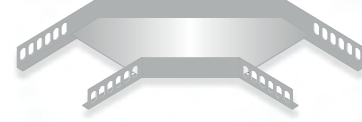
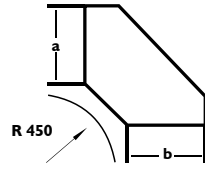

RADUS 450

NORMAL TİP T DÖNÜŞ ELEMANLARI
NORMAL TYPE TEE-BRANCHES

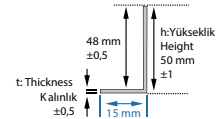
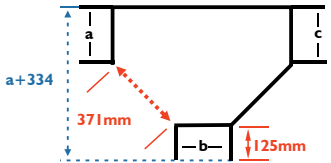
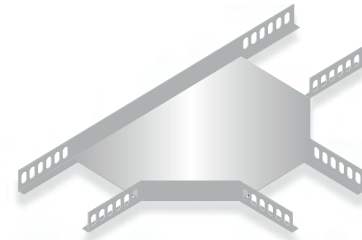
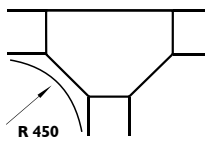

RADUS 450

NORMAL TİP DÖRTLÜ BAĞLANTILAR
NORMAL TYPE CROSSINGS

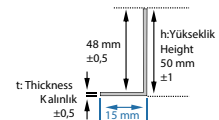
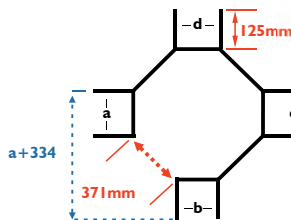
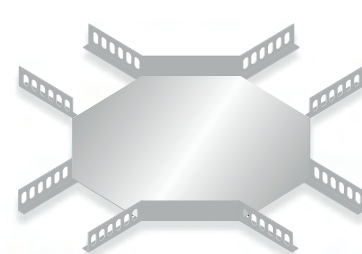
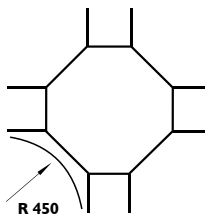

AÇIKLAMALAR / INSTRUCTIONS : Ekstra / Extra

Tüm dönüş uygulamaları, Metrik 8 civata ve somun kullanımına uygundur.
Belirtilen ağırlıklar kesim ağırlıklarıdır.

All the bend implementation are convenient for M8 bolt and Nut usage.
The indicated weights are the weights before fabrication.

Sipariş Kodu (Order Code)	a, b (mm)	h (mm)	t (mm)	Kg/Adet (Kg/Pcs.)
AP-YDH105/300	55	51	1,50	1,036
AP-YDH107/300	75	51	1,50	1,140
AP-YDH110/300	105	51	1,50	1,327
AP-YDH112/300	125	51	1,50	1,458
AP-YDH115/300	155	51	1,50	1,665
AP-YDH120/300	205	51	1,50	2,052
AP-YDH125/300	255	51	1,50	2,452
AP-YDH130/300	305	51	2,00	3,574
AP-YDH140/300	405	51	2,00	4,925
AP-YDH150/300	505	51	2,00	6,791
AP-YDH160/300	605	51	2,00	7,743

► AÇIKLAMALAR / INSTRUCTIONS :

NOT: DÖNÜŞ MODÜLLERİNDEKİ ÖZEL UYGULAMALAR İÇİN ÖRNEK SİPARİŞ h:40mm a:100mm b:200mm "90° Yatay Dönüş"

NOTE: The example order for special applications in bend modules. h:40mm. a:100mm b:200mm Bend 90°.

Sipariş Kodu (Order Code)	a, b, c (mm)	h (mm)	t (mm)	Kg/Adet (Kg/Pcs.)
AP-TDH205/300	55	51	1,50	2,400
AP-TDH207/300	75	51	1,50	2,555
AP-TDH210/300	105	51	1,50	2,795
AP-TDH212/300	125	51	1,50	2,959
AP-TDH215/300	155	51	1,50	3,655
AP-TDH220/300	205	51	1,50	3,778
AP-TDH225/300	255	51	1,50	4,808
AP-TDH230/300	305	51	2,00	5,539
AP-TDH240/300	405	51	2,00	6,817
AP-TDH250/300	505	51	2,00	8,189
AP-TDH260/300	605	51	2,00	9,127

►► AÇIKLAMALAR / INSTRUCTIONS :

NOT: DÖNÜŞ MODÜLLERİNDEKİ ÖZEL UYGULAMALAR İÇİN ÖRNEK SİPARİŞ h:40mm a:300mm b:200mm c:300mm "T" DÖNÜŞ

NOTE: The example order for special applications in bend modules. h:40mm. a:100mm b:200mm c:300mm "Tee branch".

Sipariş Kodu (Order Code)	a, b, c, d (mm)	h (mm)	t (mm)	Kg/Adet (Kg/Pcs.)
AP-DDH305/300	55	51	1,50	2,798
AP-DDH307/300	75	51	1,50	2,952
AP-DDH310/300	105	51	1,50	3,315
AP-DDH312/300	125	51	1,50	3,538
AP-DDH315/300	155	51	1,50	3,891
AP-DDH320/300	205	51	1,50	4,526
AP-DDH325/300	255	51	1,50	5,219
AP-DDH330/300	305	51	2,00	7,166
AP-DDH340/300	405	51	2,00	9,184
AP-DDH350/300	505	51	2,00	11,484
AP-DDH360/300	605	51	2,00	14,067

►►► AÇIKLAMALAR / INSTRUCTIONS :

NOT: DÖNÜŞ MODÜLLERİNDEKİ ÖZEL UYGULAMALAR İÇİN ÖRNEK SİPARİŞ h:40mm a:300mm b:200mm c:300mm d:200mm "Dörtlü" DÖNÜŞ

NOTE: The example order for special applications in bend modules. h:40mm. a:100mm b:200mm c:300mm d:200mm "crossing"

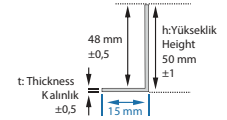
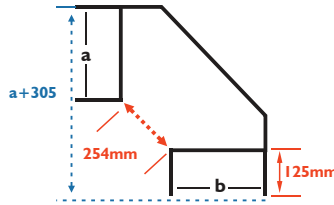
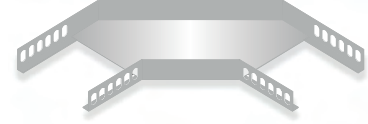
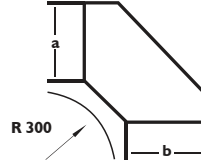
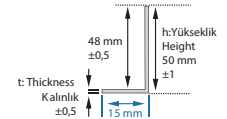
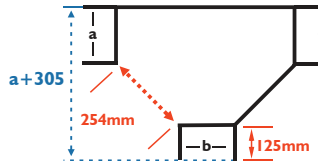
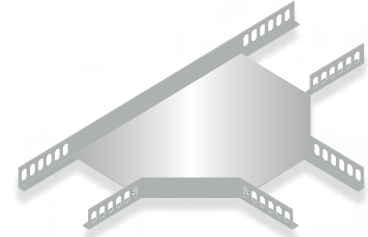
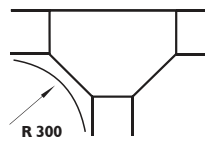
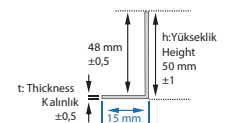
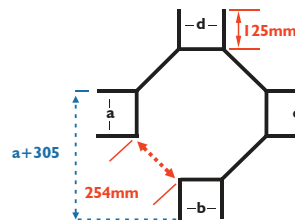
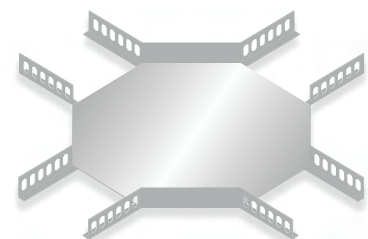
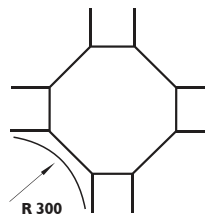
RADUS 300
NORMAL TİP 90° DÖNÜŞ ELEMANLARI
 NORMAL TYPE 90° BENDS

RADUS 300
NORMAL TİP T DÖNÜŞ ELEMANLARI
 NORMAL TYPE TEE-BRANCHES

RADUS 300
NORMAL TİP DÖRTLÜ BAĞLANTILAR
 NORMAL TYPE CROSSINGS

AÇIKLAMALAR / INSTRUCTIONS : Ekstra / Extra

Tüm dönüş uygulamaları, Metrik 8 civata ve somun kullanımına uygundur. Belirtilen ağırlıklar kesim ağırlıklarıdır.

All the bend implementation are convenient for M8 bolt and Nut usage. The indicated weights are the weights before fabrication.

NORMAL TİP YATAY VE DİKEY DÖNÜŞ ELEMANLARI

NORMAL TYPE HORIZONTAL AND VERTICAL BENDS

info@apexelektrik.com



NORMAL
TİP KABLO
KANALLARI

Sipariş Kodu (Order Code)	a (mm)	b (mm)	c (mm)	h (mm)	t (mm)	Kg/Adet (Kg/Pcs.)
AP-YDHI05/135	55	115	105	51	1,50	1,205
AP-YDHI07/135	75	135	115	51	1,50	1,299
AP-YDHI10/135	105	165	130	51	1,50	1,462
AP-YDHI12/135	125	185	140	51	1,50	1,592
AP-YDHI15/135	155	215	155	51	1,50	1,786
AP-YDHI20/135	205	265	180	51	1,50	1,988
AP-YDHI25/135	255	315	205	51	1,50	2,294
AP-YDHI30/135	305	365	230	51	2,00	3,044
AP-YDHI40/135	405	465	285	51	2,00	3,810
AP-YDHI50/135	505	565	335	51	2,00	4,636
AP-YDHI60/135	605	665	385	51	2,00	5,527

NORMAL TİP 135° DÖNÜŞ ELEMANI

NORMAL TYPE 135° BENDS

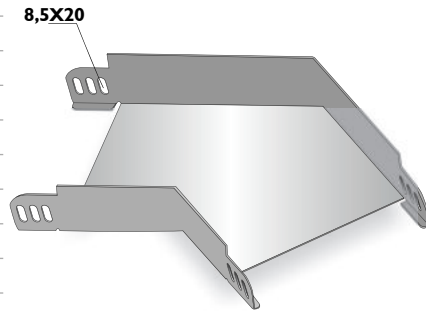

► AÇIKLAMALAR / INSTRUCTIONS :

NOT: Lütfen siparişlerinizde 135° dönüş tipini ve sipariş kodunu belirtiniz.

! Metrik 8 cıvata ve somun kullanımına uygundur. Belirtilen ağırlıklar kesim ağırlıklarıdır.

NOTE: Please indicate the 135° Bend type and order code.

! M8 bolt and Nut usage. The indicated weights are the weights before fabrication.

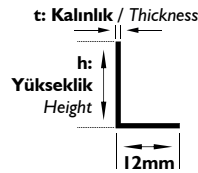
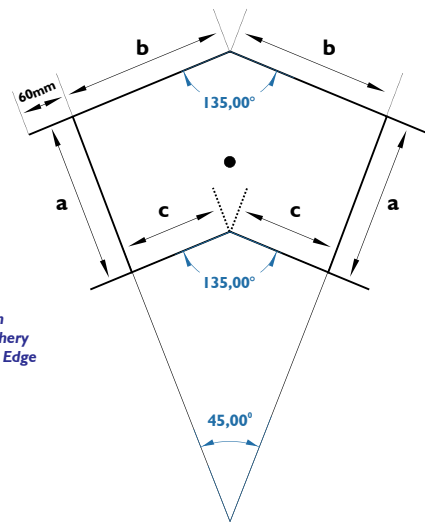

a: Genişlik / Width
b: Dış Kenar / Periphery
c: İç Kenar / Inner Edge

Sipariş Kodu (Order Code)	w (mm)	h (mm)	t (mm)	Kg/Adet (Kg/Pcs.)
AP-BH505	50	50	1,00	0,904
AP-BH507	70	50	1,00	1,030
AP-BH510	100	50	1,00	1,218
AP-BH512	120	50	1,00	1,344
AP-BH515	150	50	1,20	1,839
AP-BH520	200	50	1,20	2,216
AP-BH525	250	50	1,20	3,240
AP-BH530	300	50	1,50	3,711
AP-BH540	400	50	1,50	4,654
AP-BH550	500	50	1,50	5,596
AP-BH560	600	50	1,50	6,538

İÇ VE DIŞ BÜKEY ELEMANLAR

VERTICAL INSIDE AND OUTSIDE BENDS

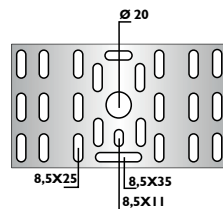
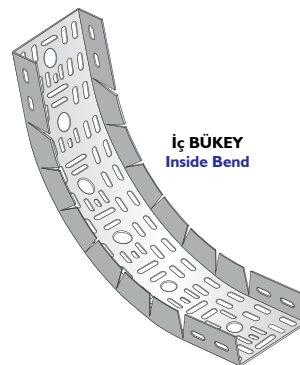
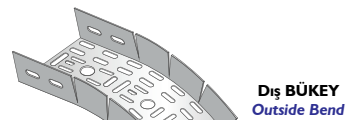
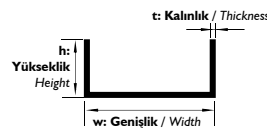

► AÇIKLAMALAR / INSTRUCTIONS :

NOT: Lütfen siparişlerinizde bükey tipini ve sipariş kodunu belirtiniz.

! Standart uzunluk 800mm. İsteğe bağlı olarak uzunluklar değişebilir.

! Metrik 8 cıvata ve somun kullanımına uygundur. Belirtilen ağırlıklar kesim ağırlıklarıdır.

NOTE: Please indicate the vertical adjustable inside and outside bends type and order code.

! Standart Length is 800mm. On request the Lengths can change.

! M8 bolt and Nut usage. The indicated weights are the weights before fabrication.

Sipariş Kodu (Order Code)	w (mm)	h (mm)	t (mm)	Kg/Takım (Kg/Set)
AP-RZH1-50	50	50	1,50	0,210
AP-RZH1-100	100	50	1,50	0,240
AP-RZH1-150	150	50	1,50	0,269
AP-RZH1-200	200	50	1,50	0,298
AP-RZH1-250	250	50	1,50	0,328
AP-RZH1-300	300	50	1,50	0,357

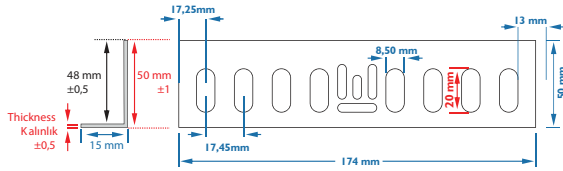

SOLA / LEFT

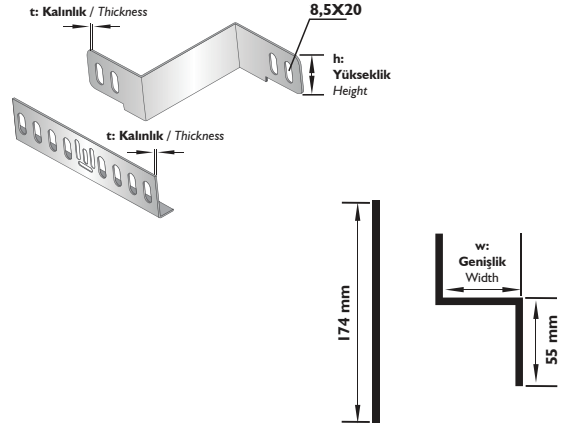
Z TİPİ REDÜKSİYONLAR SOLA
Z TYPE REDUCERS LEFT

Sipariş Kodu (Order Code)	w (mm)	h (mm)	t (mm)	Kg/Takım (Kg/Set)
AP-RZH1-50	50	50	1,50	0,210
AP-RZH1-100	100	50	1,50	0,240
AP-RZH1-150	150	50	1,50	0,269
AP-RZH1-200	200	50	1,50	0,298
AP-RZH1-250	250	50	1,50	0,328
AP-RZH1-300	300	50	1,50	0,357

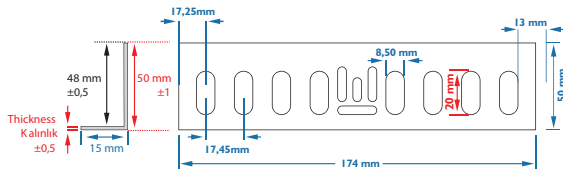

SAĞA / RIGHT

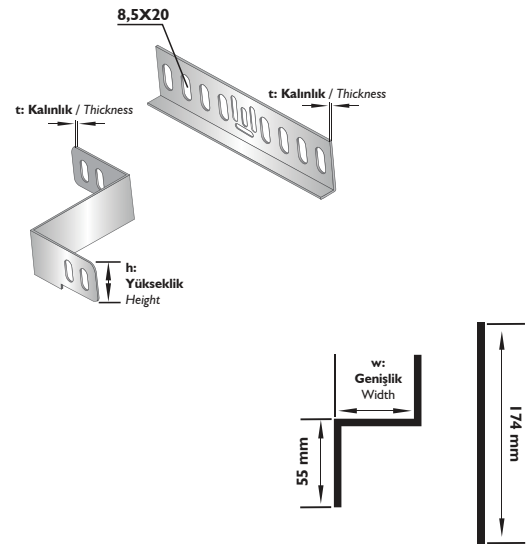
Z TİPİ REDÜKSİYONLAR SAĞA
Z TYPE REDUCERS RIGHT

Sipariş Kodu (Order Code)	w (mm)	h (mm)	t (mm)	Kg/Takım (Kg/Set)
AP-RZH2-25	25	50	1,50	0,171
AP-RZH2-50	50	50	1,50	0,200
AP-RZH2-100	100	50	1,50	0,259
AP-RZH2-150	150	50	1,50	0,318
AP-RZH2-200	200	50	1,50	0,377
AP-RZH2-250	250	50	1,50	0,436

ORTADAN / CENTER

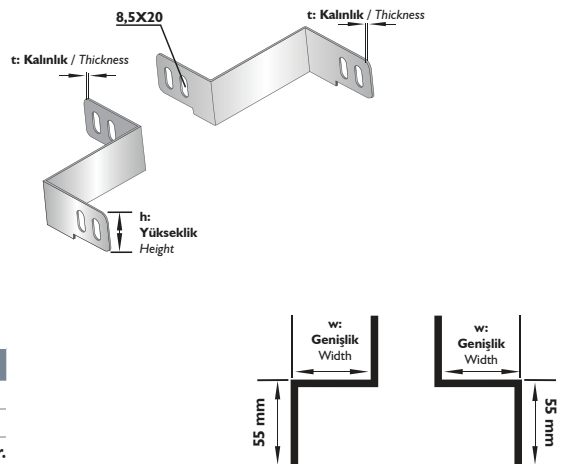
Z TİPİ REDÜKSİYONLAR ORTADAN
Z TYPE REDUCERS CENTER

► AÇIKLAMALAR / INSTRUCTIONS :

NOT: Lütfen siparişlerinizde redüksiyon tipini ve "w" ölçüsünü belirtiniz.

! Özel ölçüler için lütfen 8mm ile irtibata geçiniz.

! Metrik 8 cıvata ve somun kullanımına uygundur. Belirtilen ağırlıklar kesim ağırlıklarıdır.

NOTE: Please assert the reduction type and "w" dimension.

! For special dimensions please contact our 8mm

! M8 bolt and Nut usage. The indicated weights are the weights before fabrication.

Sipariş Kodu (Order Code)	a, b (mm)	h (mm)	t (mm)	Kg/Adet (Kg/Pcs.)
AP-YDEH105	55	61	1,20	0,485
AP-YDEH107	75	61	1,20	0,622
AP-YDEH110	105	61	1,20	0,749
AP-YDEH112	125	61	1,20	0,865
AP-YDEH115	155	61	1,20	1,039
AP-YDEH120	205	61	1,20	1,375
AP-YDEH125	255	61	1,20	1,758
AP-YDEH130	305	61	1,50	2,736
AP-YDEH140	405	61	1,50	3,989
AP-YDEH150	505	61	1,50	5,318
AP-YDEH160	605	61	1,50	7,201

► AÇIKLAMALAR / INSTRUCTIONS :

NOT: DÖNÜŞ MODÜLLERİNDEKİ ÖZEL UYGULAMALAR İÇİN ÖRNEK SİPARİŞ h:40mm a:100mm b:200mm "90° Yatay Dönüş"

NOTE: The example order for special applications in bend modules.
h:40mm. a:100mm b:200mm Bend 90°.

Sipariş Kodu (Order Code)	a, b, c (mm)	h (mm)	t (mm)	Kg/Adet (Kg/Pcs.)
AP-TDEH205	55	61	1,20	0,624
AP-TDEH207	75	61	1,20	0,780
AP-TDEH210	105	61	1,20	0,898
AP-TDEH212	125	61	1,20	1,024
AP-TDEH215	155	61	1,20	1,214
AP-TDEH220	205	61	1,20	1,576
AP-TDEH225	255	61	1,20	1,986
AP-TDEH230	305	61	1,50	3,054
AP-TDEH240	405	61	1,50	4,373
AP-TDEH250	505	61	1,50	5,927
AP-TDEH260	605	61	1,50	7,717

►► AÇIKLAMALAR / INSTRUCTIONS :

NOT: DÖNÜŞ MODÜLLERİNDEKİ ÖZEL UYGULAMALAR İÇİN ÖRNEK SİPARİŞ h:40mm a:300mm b:200mm c:300mm "T" DÖNÜŞ

NOTE: The example order for special applications in bend modules.
h:40mm. a:100mm b:200mm c:300mm "Tee branch".

Sipariş Kodu (Order Code)	a, b, c, d (mm)	h (mm)	t (mm)	Kg/Adet (Kg/Pcs.)
AP-DDEH305	55	61	1,20	0,803
AP-DDEH307	75	61	1,20	0,977
AP-DDEH310	105	61	1,20	1,077
AP-DDEH312	125	61	1,20	1,213
AP-DDEH315	155	61	1,20	1,419
AP-DDEH320	205	61	1,20	1,775
AP-DDEH325	255	61	1,20	2,244
AP-DDEH330	305	61	1,50	3,409
AP-DDEH340	405	61	1,50	4,793
AP-DDEH350	505	61	1,50	6,414
AP-DDEH360	605	61	1,50	8,269

►►► AÇIKLAMALAR / INSTRUCTIONS :

NOT: DÖNÜŞ MODÜLLERİNDEKİ ÖZEL UYGULAMALAR İÇİN ÖRNEK SİPARİŞ h:40mm a:300mm b:200mm c:300mm d:200mm "Dörtlü" DÖNÜŞ

NOTE: The example order for special applications in bend modules.
h:40mm. a:100mm b:200mm c:300mm d:200mm "crossing"

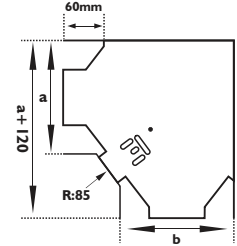
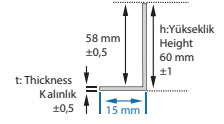
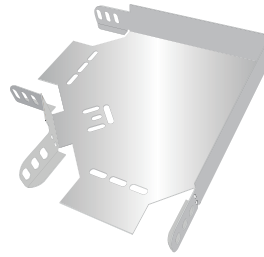
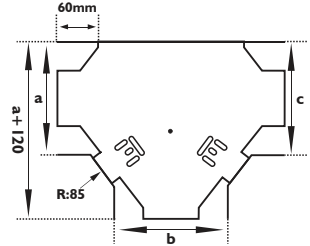
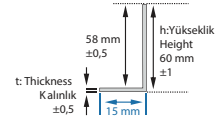
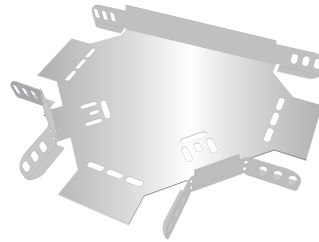
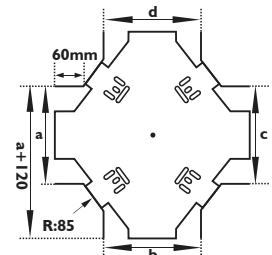
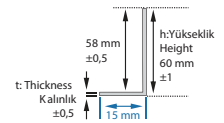
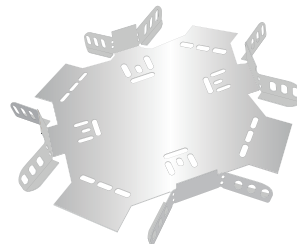
NORMAL TİP 90° DÖNÜŞ ELEMANLARI
 NORMAL TYPE 90° BENDS

NORMAL TİP T DÖNÜŞ ELEMANLARI
 NORMAL TYPE TEE-BRANCHES

NORMAL TİP DÖRTLÜ BAĞLANTILAR
 NORMAL TYPE CROSSINGS

AÇIKLAMALAR / INSTRUCTIONS : Ekstra / Extra

Tüm dönüş uygulamaları, Metrik 8 civata ve somun kullanımına uygundur. Belirtilen ağırlıklar kesim ağırlıklarıdır.

All the bend implementation are convenient for M8 bolt and Nut usage. The indicated weights are the weights before fabrication.

Sipariş Kodu (Order Code)	a, b (mm)	h (mm)	t (mm)	Kg/Adet (Kg/Pcs.)
AP-YDEH105/300	55	61	1,50	1,166
AP-YDEH107/300	75	61	1,50	1,273
AP-YDEH110/300	105	61	1,50	1,466
AP-YDEH112/300	125	61	1,50	1,601
AP-YDEH115/300	155	61	1,50	1,814
AP-YDEH120/300	205	61	1,50	2,211
AP-YDEH125/300	255	61	1,50	2,620
AP-YDEH130/300	305	61	2,00	3,788
AP-YDEH140/300	405	61	2,00	5,162
AP-YDEH150/300	505	61	2,00	6,752
AP-YDEH160/300	605	61	2,00	8,027

AÇIKLAMALAR / INSTRUCTIONS :

NOT: DÖNÜŞ MODÜLLERİNDEKİ ÖZEL UYGULAMALAR İÇİN ÖRNEK
SİPARİŞ h:40mm a:100mm b:200mm "90° Yatay Dönüş"

NOTE: The example order for special applications in bend modules.
h:40mm. a:100mm b:200mm Bend 90°.

Sipariş Kodu (Order Code)	a, b, c (mm)	h (mm)	t (mm)	Kg/Adet (Kg/Pcs.)
AP-TDEH205/300	55	61	1,50	2,597
AP-TDEH207/300	75	61	1,50	2,754
AP-TDEH210/300	105	61	1,50	2,997
AP-TDEH212/300	125	61	1,50	3,164
AP-TDEH215/300	155	61	1,50	3,869
AP-TDEH220/300	205	61	1,50	3,993
AP-TDEH225/300	255	61	1,50	5,034
AP-TDEH230/300	305	61	2,00	5,810
AP-TDEH240/300	405	61	2,00	7,103
AP-TDEH250/300	505	61	2,00	8,489
AP-TDEH260/300	605	61	2,00	9,441

AÇIKLAMALAR / INSTRUCTIONS :

NOT: DÖNÜŞ MODÜLLERİNDEKİ ÖZEL UYGULAMALAR İÇİN ÖRNEK
SİPARİŞ h:40mm a:300mm b:200mm c:300mm "T" DÖNÜŞ

NOTE: The example order for special applications in bend modules.
h:40mm. a:100mm b:200mm c:300mm "Tee branch".

Sipariş Kodu (Order Code)	a, b, c, d (mm)	h (mm)	t (mm)	Kg/Adet (Kg/Pcs.)
AP-DDEH305/300	55	61	1,50	3,036
AP-DDEH307/300	75	61	1,50	3,189
AP-DDEH310/300	105	61	1,50	3,552
AP-DDEH312/300	125	61	1,50	3,776
AP-DDEH315/300	155	61	1,50	4,128
AP-DDEH320/300	205	61	1,50	4,763
AP-DDEH325/300	255	61	1,50	5,456
AP-DDEH330/300	305	61	2,00	7,451
AP-DDEH340/300	405	61	2,00	9,468
AP-DDEH350/300	505	61	2,00	11,769
AP-DDEH360/300	605	61	2,00	14,352

AÇIKLAMALAR / INSTRUCTIONS :

NOT: DÖNÜŞ MODÜLLERİNDEKİ ÖZEL UYGULAMALAR İÇİN ÖRNEK
SİPARİŞ h:40mm a:300mm b:200mm c:300mm d:200mm "Dörtlü" DÖNÜŞ

NOTE: The example order for special applications in bend modules.
h:40mm. a:100mm b:200mm c:300mm d:200mm "crossing"

RADUS 300

NORMAL TİP 90° DÖNÜŞ ELEMANLARI
NORMAL TYPE 90° BENDS

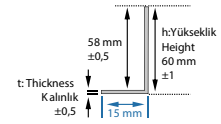
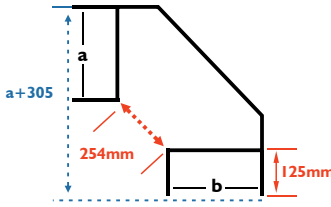
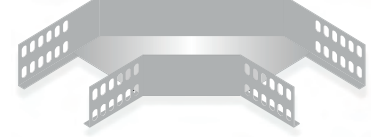
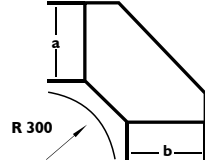

RADUS 300

NORMAL TİP T DÖNÜŞ ELEMANLARI
NORMAL TYPE TEE-BRANCHES

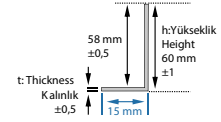
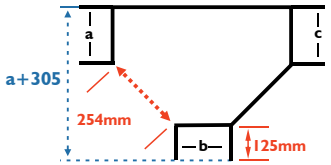
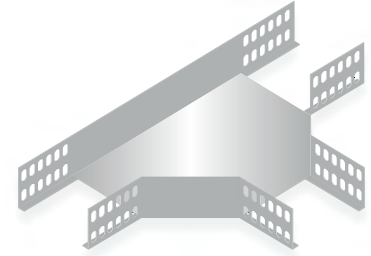
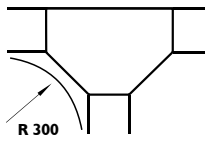

RADUS 300

NORMAL TİP DÖRTLÜ BAĞLANTILAR
NORMAL TYPE CROSSINGS

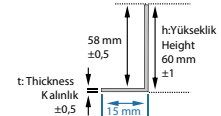
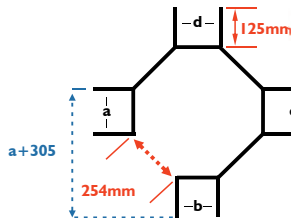
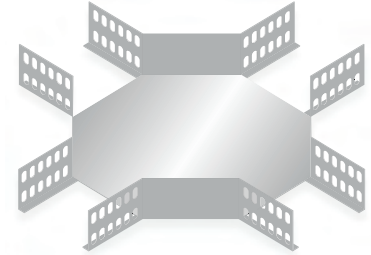
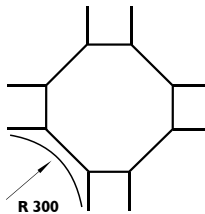

AÇIKLAMALAR / INSTRUCTIONS : Ekstra / Extra

Tüm dönüş uygulamaları, Metrik 8 civata ve somun kullanımına uygundur.
Belirtilen ağırlıklar kesim ağırlıklarıdır.

All the bend implementation are convenient for M8 bolt and Nut usage.
The indicated weights are the weights before fabrication.

Sipariş Kodu (Order Code)	a, b (mm)	h (mm)	t (mm)	Kg/Adet (Kg/Pcs.)
AP-YDEH105/450	55	61	1,50	1,345
AP-YDEH107/450	75	61	1,50	1,480
AP-YDEH110/450	105	61	1,50	1,714
AP-YDEH112/450	125	61	1,50	1,877
AP-YDEH115/450	155	61	1,50	2,131
AP-YDEH120/450	205	61	1,50	2,597
AP-YDEH125/450	255	61	1,50	3,075
AP-YDEH130/450	305	61	2,00	4,416
AP-YDEH140/450	405	61	2,00	5,955
AP-YDEH150/450	505	61	2,00	7,711
AP-YDEH160/450	605	61	2,00	9,151

► AÇIKLAMALAR / INSTRUCTIONS :

NOT: DÖNÜŞ MODÜLLERİNDEKİ ÖZEL UYGULAMALAR İÇİN ÖRNEK SİPARİŞ h:40mm a:100mm b:200mm "90° Yatay Dönüş"

NOTE: The example order for special applications in bend modules. h:40mm. a:100mm b:200mm Bend 90°.

Sipariş Kodu (Order Code)	a, b, c (mm)	h (mm)	t (mm)	Kg/Adet (Kg/Pcs.)
AP-TDEH205/450	55	61	1,50	3,764
AP-TDEH207/450	75	61	1,50	3,979
AP-TDEH210/450	105	61	1,50	4,310
AP-TDEH212/450	125	61	1,50	4,535
AP-TDEH215/450	155	61	1,50	5,474
AP-TDEH220/450	205	61	1,50	5,597
AP-TDEH225/450	255	61	1,50	6,930
AP-TDEH230/450	305	61	2,00	8,086
AP-TDEH240/450	405	61	2,00	9,729
AP-TDEH250/450	505	61	2,00	11,465
AP-TDEH260/450	605	61	2,00	12,768

►► AÇIKLAMALAR / INSTRUCTIONS :

NOT: DÖNÜŞ MODÜLLERİNDEKİ ÖZEL UYGULAMALAR İÇİN ÖRNEK SİPARİŞ h:40mm a:300mm b:200mm c:300mm "T" DÖNÜŞ

NOTE: The example order for special applications in bend modules. h:40mm. a:100mm b:200mm c:300mm "Tee branch".

Sipariş Kodu (Order Code)	a, b, c, d (mm)	h (mm)	t (mm)	Kg/Adet (Kg/Pcs.)
AP-DDEH305/450	55	61	1,50	4,525
AP-DDEH307/450	75	61	1,50	4,802
AP-DDEH310/450	105	61	1,50	5,236
AP-DDEH312/450	125	61	1,50	5,537
AP-DDEH315/450	155	61	1,50	6,006
AP-DDEH320/450	205	61	1,50	6,835
AP-DDEH325/450	255	61	1,50	7,723
AP-DDEH330/450	305	61	2,00	10,403
AP-DDEH340/450	405	61	2,00	12,887
AP-DDEH350/450	505	61	2,00	15,654
AP-DDEH360/450	605	61	2,00	18,703

►►► AÇIKLAMALAR / INSTRUCTIONS :

NOT: DÖNÜŞ MODÜLLERİNDEKİ ÖZEL UYGULAMALAR İÇİN ÖRNEK SİPARİŞ h:40mm a:300mm b:200mm c:300mm d:200mm "Dörtlü" DÖNÜŞ

NOTE: The example order for special applications in bend modules. h:40mm. a:100mm b:200mm c:300mm d:200mm "crossing"

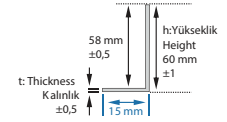
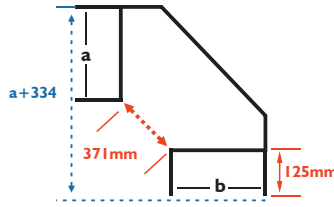
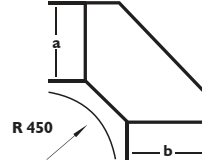
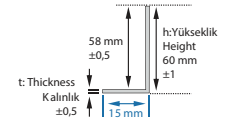
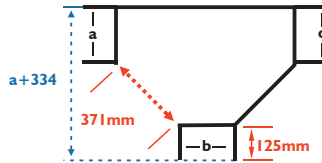
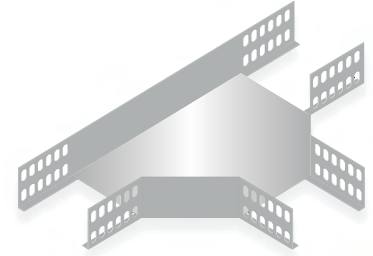
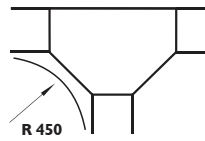
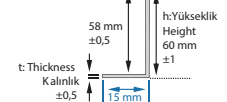
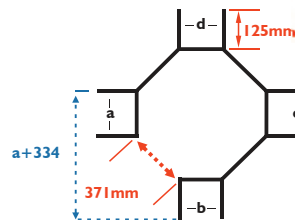
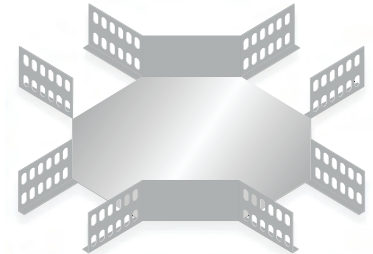
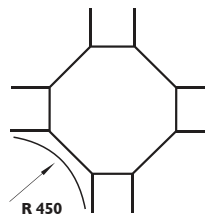
RADUS 450
NORMAL TİP 90° DÖNÜŞ ELEMANLARI
 NORMAL TYPE 90° BENDS

RADUS 450
NORMAL TİP T DÖNÜŞ ELEMANLARI
 NORMAL TYPE TEE-BRANCHES

RADUS 450
NORMAL TİP DÖRTLÜ BAĞLANTILAR
 NORMAL TYPE CROSSINGS

AÇIKLAMALAR / INSTRUCTIONS : Ekstra / Extra

Tüm dönüş uygulamaları, Metrik 8 civata ve somun kullanımına uygundur. Belirtilen ağırlıklar kesim ağırlıklarıdır.

All the bend implementation are convenient for M8 bolt and Nut usage. The indicated weights are the weights before fabrication.

Sipariş Kodu (Order Code)	a, b (mm)	h (mm)	t (mm)	Kg/Adet (Kg/Pcs.)
AP-YDEH105/600	55	61	1,50	1,538
AP-YDEH107/600	75	61	1,50	1,703
AP-YDEH110/600	105	61	1,50	1,981
AP-YDEH112/600	125	61	1,50	2,173
AP-YDEH115/600	155	61	1,50	2,449
AP-YDEH120/600	205	61	1,50	2,976
AP-YDEH125/600	255	61	1,50	3,528
AP-YDEH130/600	305	61	2,00	5,049
AP-YDEH140/600	405	61	2,00	6,722
AP-YDEH150/600	505	61	2,00	8,656
AP-YDEH160/600	605	61	2,00	10,274

AÇIKLAMALAR / INSTRUCTIONS :

NOT: DÖNÜŞ MODÜLLERİNDEKİ ÖZEL UYGULAMALAR İÇİN ÖRNEK SİPARİŞ h:40mm a:100mm b:200mm "90° Yatay Dönüş"

NOTE: The example order for special applications in bend modules. h:40mm. a:100mm b:200mm Bend 90°.

Sipariş Kodu (Order Code)	a, b, c (mm)	h (mm)	t (mm)	Kg/Adet (Kg/Pcs.)
AP-TDEH205/600	55	61	1,50	5,325
AP-TDEH207/600	75	61	1,50	5,602
AP-TDEH210/600	105	61	1,50	6,025
AP-TDEH212/600	125	61	1,50	6,312
AP-TDEH215/600	155	61	1,50	7,496
AP-TDEH220/600	205	61	1,50	7,620
AP-TDEH225/600	255	61	1,50	9,260
AP-TDEH230/600	305	61	2,00	10,882
AP-TDEH240/600	405	61	2,00	12,893
AP-TDEH250/600	505	61	2,00	14,999
AP-TDEH260/600	605	61	2,00	16,970

AÇIKLAMALAR / INSTRUCTIONS :

NOT: DÖNÜŞ MODÜLLERİNDEKİ ÖZEL UYGULAMALAR İÇİN ÖRNEK SİPARİŞ h:40mm a:300mm b:200mm c:300mm "T" DÖNÜŞ

NOTE: The example order for special applications in bend modules. h:40mm. a:100mm b:200mm c:300mm "Tee branch".

Sipariş Kodu (Order Code)	a, b, c, d (mm)	h (mm)	t (mm)	Kg/Adet (Kg/Pcs.)
AP-DDEH305/600	55	61	1,50	6,503
AP-DDEH307/600	75	61	1,50	6,865
AP-DDEH310/600	105	61	1,50	7,425
AP-DDEH312/600	125	61	1,50	7,810
AP-DDEH315/600	155	61	1,50	8,406
AP-DDEH320/600	205	61	1,50	9,445
AP-DDEH325/600	255	61	1,50	10,544
AP-DDEH330/600	305	61	2,00	14,042
AP-DDEH340/600	405	61	2,00	17,032
AP-DDEH350/600	505	61	2,00	20,304
AP-DDEH360/600	605	61	2,00	23,859

AÇIKLAMALAR / INSTRUCTIONS :

NOT: DÖNÜŞ MODÜLLERİNDEKİ ÖZEL UYGULAMALAR İÇİN ÖRNEK SİPARİŞ h:40mm a:300mm b:200mm c:300mm d:200mm "Dörtlü" DÖNÜŞ

NOTE: The example order for special applications in bend modules. h:40mm. a:100mm b:200mm c:300mm d:200mm "crossing"

RADUS 600

NORMAL TİP 90° DÖNÜŞ ELEMANLARI
NORMAL TYPE 90° BENDS

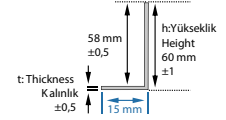
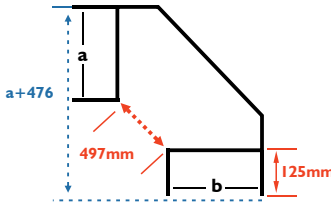
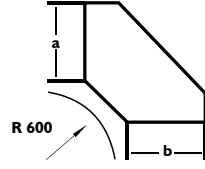

RADUS 600

NORMAL TİP T DÖNÜŞ ELEMANLARI
NORMAL TYPE TEE-BRANCHES

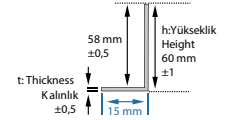
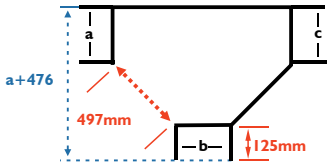
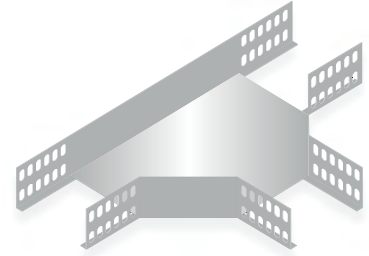
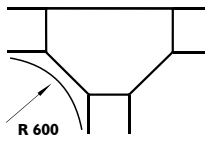

RADUS 600

NORMAL TİP DÖRTLÜ BAĞLANTILAR
NORMAL TYPE CROSSINGS

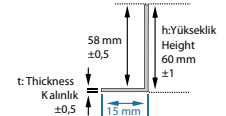
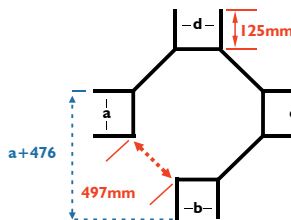
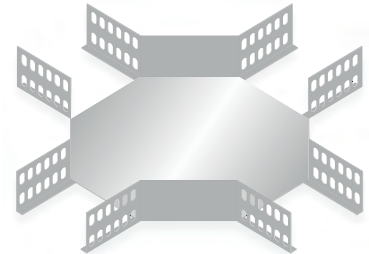
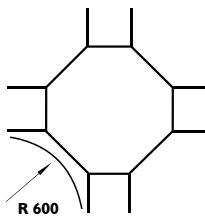

AÇIKLAMALAR / INSTRUCTIONS : Ekstra / Extra

Tüm dönüş uygulamaları, Metrik 8 civata ve somun kullanımına uygundur. Belirtilen ağırlıklar kesim ağırlıklarıdır.

All the bend implementation are convenient for M8 bolt and Nut usage. The indicated weights are the weights before fabrication.

Sipariş Kodu (Order Code)	a (mm)	b (mm)	c (mm)	h (mm)	t (mm)	Kg/Adet (Kg/Pcs.)
AP-YDEH105/135	55	115	105	61	1,50	1,316
AP-YDEH107/135	75	135	115	61	1,50	1,425
AP-YDEH110/135	105	165	130	61	1,50	1,589
AP-YDEH112/135	125	185	140	61	1,50	1,722
AP-YDEH115/135	155	215	155	61	1,50	1,921
AP-YDEH120/135	205	265	180	61	1,50	2,125
AP-YDEH125/135	255	315	205	61	1,50	2,436
AP-YDEH130/135	305	365	230	61	2,00	3,191
AP-YDEH140/135	405	465	285	61	2,00	3,967
AP-YDEH150/135	505	565	335	61	2,00	4,802
AP-YDEH160/135	605	665	385	61	2,00	4,469

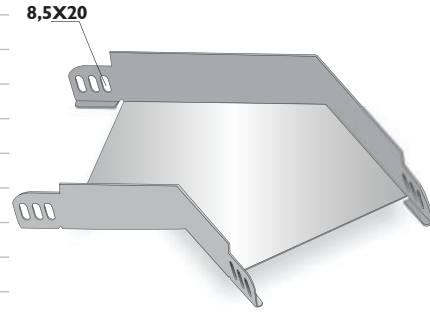
NORMAL TİP 135° DÖNÜŞ ELEMANI
 NORMAL TYPE 135° BENDS

AÇIKLAMALAR / INSTRUCTIONS :

NOT: Lütfen siparişlerinizde 135° dönüş tipini ve sipariş kodunu belirtiniz.

! Metrik 8 cıvata ve somun kullanımına uygundur. Belirtilen ağırlıklar kesim ağırlıklarıdır.

NOTE: Please indicate the 135° Bend type and order code.

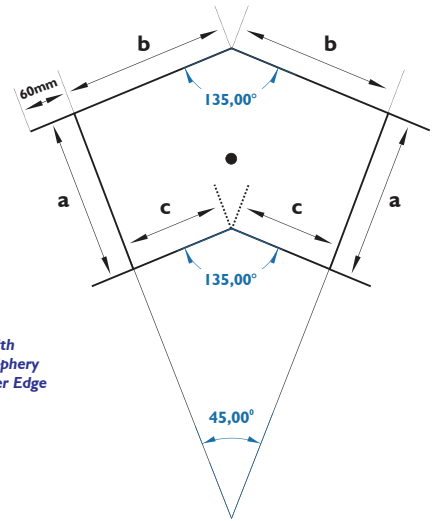
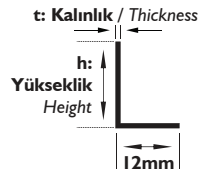
! M8 bolt and Nut usage. The indicated weights are the weights before fabrication.



a : Genişlik / Width
 b : Dış Kenar / Periphery
 c : İç Kenar / Inner Edge

Sipariş Kodu (Order Code)	w (mm)	h (mm)	t (mm)	Kg/Adet (Kg/Pcs.)
AP-BEH505	50	60	1,00	1,030
AP-BEH507	70	60	1,00	1,156
AP-BEH510	100	60	1,00	1,344
AP-BEH512	120	60	1,00	1,470
AP-BEH515	150	60	1,20	1,990
AP-BEH520	200	60	1,20	2,366
AP-BEH525	250	60	1,20	3,429
AP-BEH530	300	60	1,50	3,900
AP-BEH540	400	60	1,50	4,842
AP-BEH550	500	60	1,50	5,784
AP-BEH560	600	60	1,50	6,726

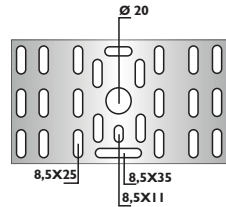
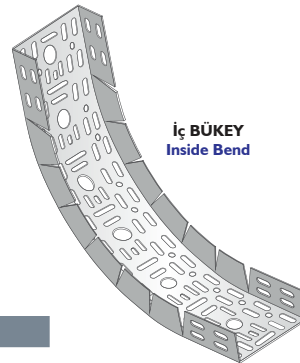
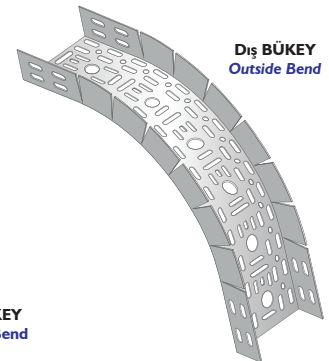
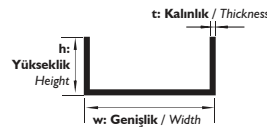
İÇ VE DIŞ BÜKEY ELEMANLAR
 VERTICAL INSIDE AND OUTSIDE BENDS

AÇIKLAMALAR / INSTRUCTIONS :

NOT: Lütfen siparişlerinizde bükey tipini ve sipariş kodunu belirtiniz.

! Standart uzunluk 800mm. İsteğe bağlı olarak uzunluklar değişebilir.

! Metrik 8 cıvata ve somun kullanımına uygundur. Belirtilen ağırlıklar kesim ağırlıklarıdır.

NOTE: Please indicate the vertical adjustable inside and outside bends type and order code.

! Standart Length is 800mm. On request the Lengths can change.

! M8 bolt and Nut usage. The indicated weights are the weights before fabrication.

Z TİPİ REDÜKSİYONLAR Z TYPE REDUCERS

info@apexelektrik.com

Sipariş Kodu (Order Code)	w (mm)	h (mm)	t (mm)	Kg/Takım (Kg/Set)
AP-RZEHI-50	50	60	1,50	0,246
AP-RZEHI-100	100	60	1,50	0,281
AP-RZEHI-150	150	60	1,50	0,317
AP-RZEHI-200	200	60	1,50	0,352
AP-RZEHI-250	250	60	1,50	0,387
AP-RZEHI-300	300	60	1,50	0,423

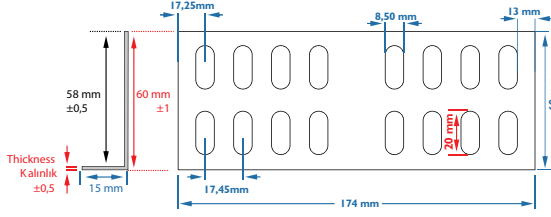

SOLA / LEFT

Z TİPİ REDÜKSİYONLAR SOLA Z TYPE REDUCERS LEFT

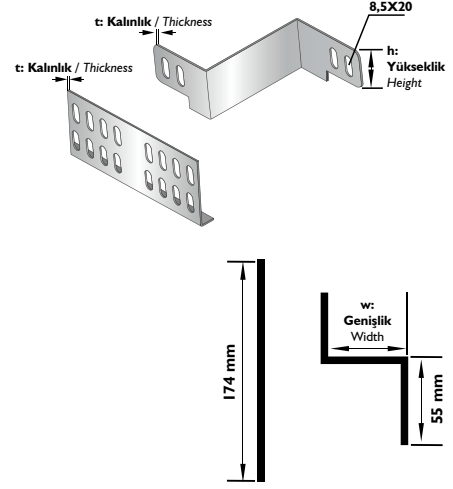

Sipariş Kodu (Order Code)	w (mm)	h (mm)	t (mm)	Kg/Takım (Kg/Set)
AP-RZEHI-50	50	60	1,50	0,246
AP-RZEHI-100	100	60	1,50	0,281
AP-RZEHI-150	150	60	1,50	0,317
AP-RZEHI-200	200	60	1,50	0,352
AP-RZEHI-250	250	60	1,50	0,387
AP-RZEHI-300	300	60	1,50	0,423

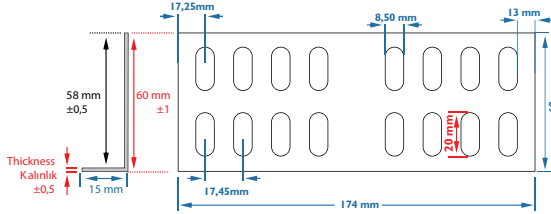

SAĞA / RIGHT

Z TİPİ REDÜKSİYONLAR SAĞA Z TYPE REDUCERS RIGHT

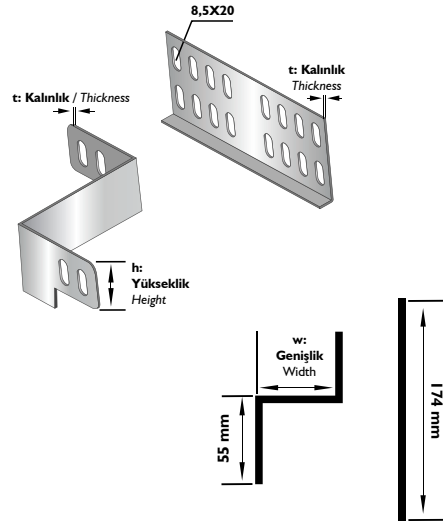

Sipariş Kodu (Order Code)	w (mm)	h (mm)	t (mm)	Kg/Takım (Kg/Set)
AP-RZEH2-25	25	60	1,50	0,205
AP-RZEH2-50	50	60	1,50	0,240
AP-RZEH2-100	100	60	1,50	0,311
AP-RZEH2-150	150	60	1,50	0,382
AP-RZEH2-200	200	60	1,50	0,452
AP-RZEH2-250	250	60	1,50	0,523

ORTADAN / CENTER

Z TİPİ REDÜKSİYONLAR ORTADAN Z TYPE REDUCERS CENTER

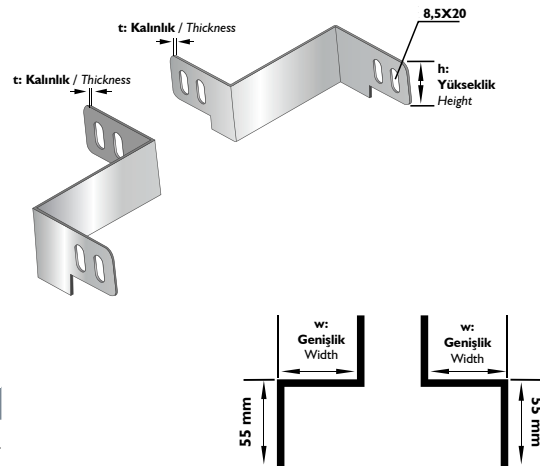

AÇIKLAMALAR / INSTRUCTIONS :

NOT: Lütfen siparişlerinizde redüksiyon tipini ve "w" ölçüsünü belirtiniz.

! Özel ölçüler için lütfen firmamız ile irtibata geçiniz.

! Metrik 8 cıvata ve somun kullanımına uygundur. Belirtilen ağırlıklar kesim ağırlıklarıdır.

NOTE: Please assert the reduction type and "w" dimension.

! For special dimensions please contact our firm

! M8 bolt and Nut usage. The indicated weights are the weights before fabrication.

