

KAP

Kablo Kanal ve Merdiven Kapakları Cable Tray And Ladder Covers

A P E X M E T A L C A B L E T R A Y S Y S T E M S

KAP Serisi / Serie

ve Aksesuarlar
and Accessories

KAP

Kablo Kanal ve Merdiven Kapakları Cable Tray And Ladder Covers

KAP

Sayfa No Page No	İNDEKS / INDEX
KAP 01	Kablo Kanalı-Merdiven Kapakları - Kapak Tutucular / Cable Trays and Ladder Cover- Cover Clapms
KAP 02	90° - T ve Dörtlü Dönüş Elemanı Kapakları / 90° Bend - Tee Branch - Crossing Covers
KAP 03	135° ve İç-Dış Bükey / 135° Bends and Vertical Inside and Outside Bends
KAP 04	90° - T ve Dörtlü Dönüş Elemanı Kapakları RADÜS 300 / 90° Bend - Tee Branch - Crossing Covers RADIUS 300
KAP 05	90° - T ve Dörtlü Dönüş Elemanı Kapakları RADÜS 450 / 90° Bend - Tee Branch - Crossing Covers RADIUS 450
KAP 06	90° - T ve Dörtlü Dönüş Elemanı Kapakları RADÜS 600 / 90° Bend - Tee Branch - Crossing Covers RADIUS 600

KAP SERİSİ / SERIE

KAP Serisi / Serie

Sipariş Kodu (Order Code)	w (mm)	h (mm)	t (mm)	Kg/Mt (Kg/Mt)
AP-05K.10	54	12	1,00	0,581
AP-07K.10	74	12	1,00	0,738
AP-10K.10	104	12	1,00	0,973
AP-12K.10	124	12	1,00	1,130
AP-15K.10	154	12	1,00	1,366
AP-20K.10	204	12	1,00	1,758
AP-25K.10	254	12	1,00	2,151
AP-30K.12	304	12	1,20	2,543
AP-40K.12	404	12	1,20	3,994
AP-50K.15	504	12	1,50	6,170
AP-60K.15	604	12	1,50	7,348

KANAL VE MERDİVEN KAPAKLARI
COVERS FOR TRAY AND LADDERS

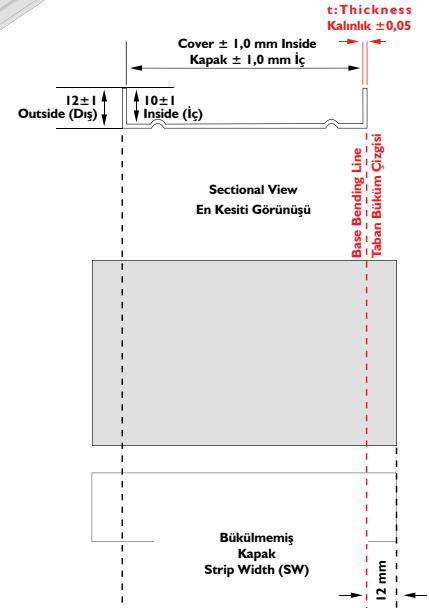
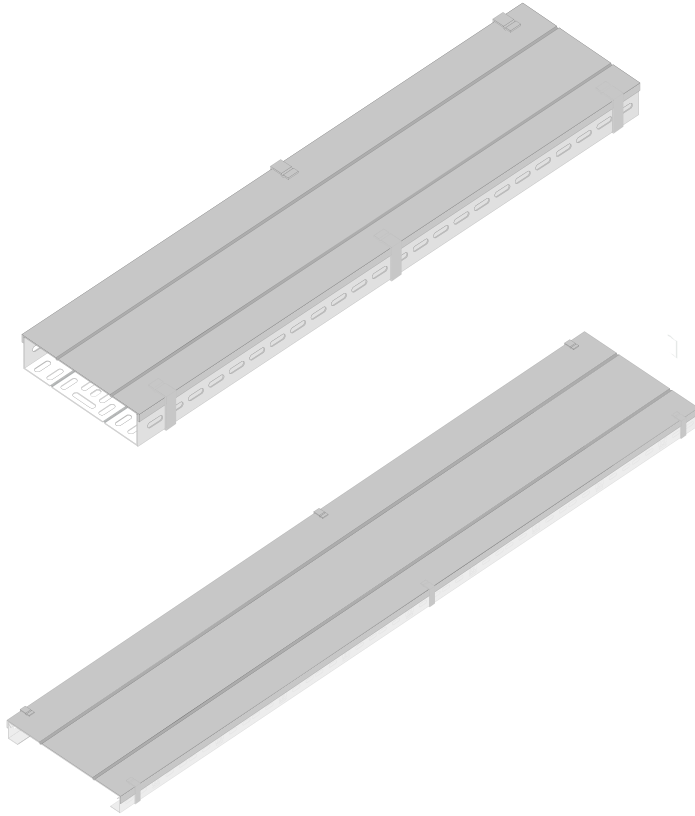

Sipariş Kodu (Order Code)	w (mm)	h (mm)	t (mm)	Gram/Adet (Gr./Pcs.)
AP-KT1	25	40	1,50	16,00
AP-KT2	25	50	1,50	18,00
AP-KT3	25	60	1,50	19,00
AP-KT4	25	100	1,50	27,00
AP-KT5	25	125	1,50	30,00
AP-KT6	25	150	1,50	35,00

KAPAK KELEPÇELERİ
COVER CLAMP

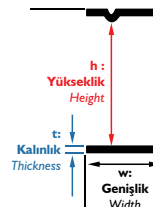
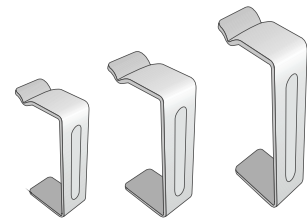

► AÇIKLAMALAR / INSTRUCTIONS :

NOT: Ölçü toleransı ± 3 mm'dir.

! Belirtilen ağırlıklar kesim ağırlıklarındadır.

! Metrik 8 civata ve somun kullanımına uygundur.

NOTE: The dimension tolerance in perforated cable trays is ±3 mm

! The indicated weights are the weights before fabrication.

! Convenient for M8 bolt and nut usage.

Sipariş Kodu (Order Code)	a, b (mm)	h (mm)	t (mm)	Kg/Adet (Kg/Pcs.)
AP-YDI05K	55	12	1,00	0,104
AP-YDI07K	75	12	1,00	0,144
AP-YDI10K	105	12	1,00	0,214
AP-YDI12K	125	12	1,00	0,269
AP-YDI15K	155	12	1,00	0,363
AP-YDI20K	205	12	1,00	0,552
AP-YDI25K	255	12	1,00	0,779
AP-YDI30K	305	12	1,50	1,569
AP-YDI40K	405	12	1,50	2,547
AP-YDI50K	505	12	1,50	3,759
AP-YDI60K	605	12	1,50	5,208

► AÇIKLAMALAR / INSTRUCTIONS :

NOT: DÖNÜŞ MODÜLLERİNDEKİ ÖZEL UYGULAMALAR İÇİN ÖRNEK
SİPARİŞ h:40mm a:100mm b:200mm "90° Yatay Dönüş"

NOTE: The example order for special applications in bend modules.
h:40mm. a:100mm b:200mm Bend 90°.

Sipariş Kodu (Order Code)	a, b, c (mm)	h (mm)	t (mm)	Kg/Adet (Kg/Pcs.)
AP-TD205K	55	12	1,00	0,140
AP-TD207K	75	12	1,00	0,186
AP-TD210K	105	12	1,00	0,266
AP-TD212K	125	12	1,00	0,327
AP-TD215K	155	12	1,00	0,431
AP-TD220K	205	12	1,00	0,635
AP-TD225K	255	12	1,00	0,878
AP-TD230K	305	12	1,50	1,741
AP-TD240K	405	12	1,50	2,766
AP-TD250K	505	12	1,50	4,025
AP-TD260K	605	12	1,50	5,521

►► AÇIKLAMALAR / INSTRUCTIONS :

NOT: DÖNÜŞ MODÜLLERİNDEKİ ÖZEL UYGULAMALAR İÇİN ÖRNEK
SİPARİŞ h:40mm a:300mm b:200mm c:300mm "T" DÖNÜŞ

NOTE: The example order for special applications in bend modules.
h:40mm. a:100mm b:200mm c:300mm "Tee branch".

Sipariş Kodu (Order Code)	a, b, c, d (mm)	h (mm)	t (mm)	Kg/Adet (Kg/Pcs.)
AP-DD305K	55	12	1,00	0,189
AP-DD307K	75	12	1,00	0,241
AP-DD310K	105	12	1,00	0,330
AP-DD312K	125	12	1,00	0,398
AP-DD315K	155	12	1,00	0,511
AP-DD320K	205	12	1,00	0,731
AP-DD325K	255	12	1,00	0,990
AP-DD330K	305	12	1,50	1,932
AP-DD340K	405	12	1,50	3,003
AP-DD350K	505	12	1,50	4,310
AP-DD360K	605	12	1,50	5,853

►►► AÇIKLAMALAR / INSTRUCTIONS :

NOT: DÖNÜŞ MODÜLLERİNDEKİ ÖZEL UYGULAMALAR İÇİN ÖRNEK
SİPARİŞ h:40mm a:300mm b:200mm c:300mm d:200mm "Dörtlü" DÖNÜŞ

NOTE: The example order for special applications in bend modules.
h:40mm. a:100mm b:200mm c:300mm d:200mm "crossing"

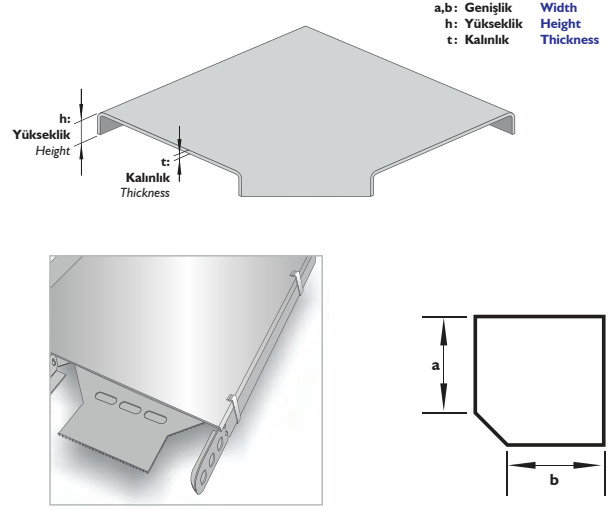
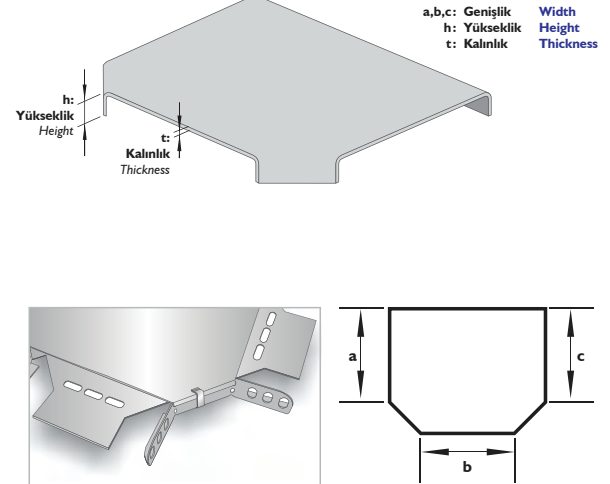
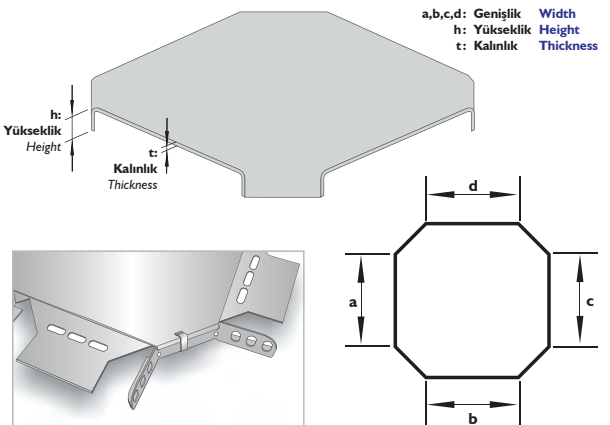
90° DÖNÜŞ KAPAKLARI
COVER BENDS 90°

T DÖNÜŞ KAPAKLARI
COVER TEE-BRANCHES

DÖRTLÜ DÖNÜŞ KAPAKLARI
COVER CROSSINGS

AÇIKLAMALAR / INSTRUCTIONS : Ekstra / Extra

Belirtilen ağırlıklar kesim ağırlıklarıdır.

The indicated weights are the weights before fabrication.

Sipariş Kodu (Order Code)	a (mm)	b (mm)	c (mm)	h (mm)	t (mm)	Kg/Adet (Kg/Pcs.)
AP-YDI05/135K	55	115	105	12	1,00	0,156
AP-YDI07/135K	75	135	115	12	1,00	0,216
AP-YDI10/135K	105	165	130	12	1,00	0,321
AP-YDI12/135K	125	185	140	12	1,00	0,403
AP-YDI15/135K	155	215	155	12	1,00	0,544
AP-YDI20/135K	205	265	180	12	1,00	0,828
AP-YDI25/135K	255	315	205	12	1,00	1,168
AP-YDI30/135K	305	365	230	12	1,50	2,353
AP-YDI40/135K	405	465	285	12	1,50	3,820
AP-YDI50/135K	505	565	335	12	1,50	5,638
AP-YDI60/135K	605	665	385	12	1,50	7,812

➤ **AÇIKLAMALAR / INSTRUCTIONS :**

NOT: Metrik 8 civata ve somun kullanımına uygundur. Belirtilen ağırlıklar kesim ağırlıklarıdır.

NOTE: M8 bolt and Nut usage. The indicated weights are the weights before fabrication.

135° DÖNÜŞ ELEMANI KAPAĞI
135° BENDS COVERS

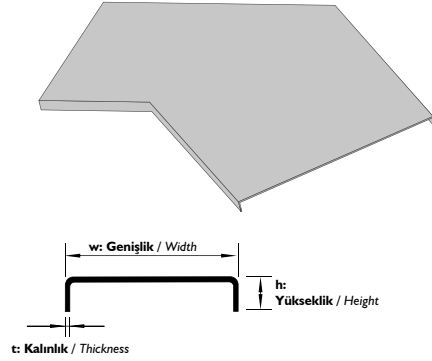

a : Genişlik Width
b : Dış Kenar Periphery
c : İç Kenar Inner Edge
h : Yükseklik Height
t : Kalınlık Thickness

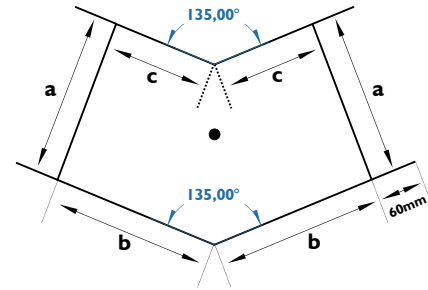
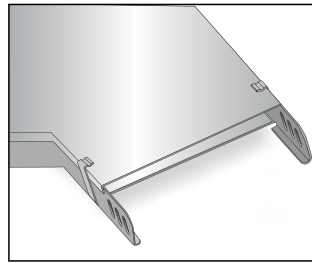

Sipariş Kodu (Order Code)	w (mm)	h (mm)	t (mm)	Kg/Adet (Kg/Pcs.)
AP-B505K	54	12	1,00	0,489
AP-B507K	74	12	1,00	0,619
AP-B510K	104	12	1,00	0,815
AP-B512K	124	12	1,00	0,944
AP-B515K	154	12	1,20	1,360
AP-B520K	204	12	1,20	1,759
AP-B525K	254	12	1,20	2,143
AP-B530K	304	12	1,50	3,176
AP-B540K	404	12	2,00	4,984
AP-B550K	504	12	2,00	6,157
AP-B560K	604	12	2,00	7,329

İÇ VE DIŞ BÜKEY ELEMANLAR
VERTICAL INSIDE AND OUTSIDE BENDS

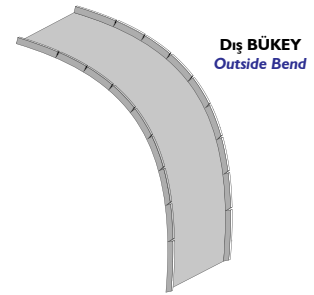
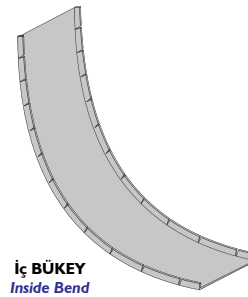

L: Uzunluk Length

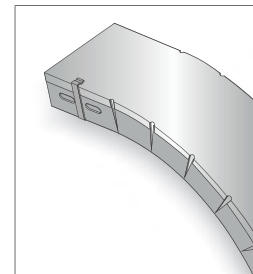
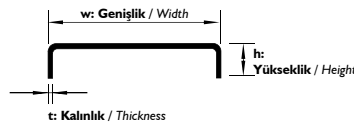

➤ **AÇIKLAMALAR / INSTRUCTIONS :**

NOT: Ölçü toleransı ± 3 mm.'dir.

! Belirtilen ağırlıklar kesim ağırlıklarıdır.

NOTE: The dimension tolerance in ± 3 mm

! The indicated weights are the weights before fabrication.

Sipariş Kodu (Order Code)	a, b (mm)	h (mm)	t (mm)	Kg/Adet (Kg/Pcs.)
AP-YD105K/300	55	12	1,50	0,375
AP-YD107K/300	75	12	1,50	0,435
AP-YD110K/300	105	12	1,50	0,525
AP-YD112K/300	125	12	1,50	0,645
AP-YD115K/300	155	12	1,50	0,825
AP-YD120K/300	205	12	1,50	1,125
AP-YD125K/300	255	12	1,50	1,425
AP-YD130K/300	305	12	2,00	2,250
AP-YD140K/300	405	12	2,00	3,720
AP-YD150K/300	505	12	2,00	5,160
AP-YD160K/300	605	12	2,00	6,900

► AÇIKLAMALAR / INSTRUCTIONS :

NOT: DÖNÜŞ MODÜLLERİNDEKİ ÖZEL UYGULAMALAR İÇİN ÖRNEK SİPARİŞ h:40mm a:100mm b:200mm "90° Yatay Dönüş"

NOTE: The example order for special applications in bend modules. h:40mm. a:100mm b:200mm Bend 90°.

Sipariş Kodu (Order Code)	a, b, c (mm)	h (mm)	t (mm)	Kg/Adet (Kg/Pcs.)
AP-TD205K/300	55	12	1,50	0,975
AP-TD207K/300	75	12	1,50	1,185
AP-TD210K/300	105	12	1,50	1,500
AP-TD212K/300	125	12	1,50	1,740
AP-TD215K/300	155	12	1,50	2,100
AP-TD220K/300	205	12	1,50	2,700
AP-TD225K/300	255	12	1,50	3,300
AP-TD230K/300	305	12	2,00	5,040
AP-TD240K/300	405	12	2,00	7,380
AP-TD250K/300	505	12	2,00	9,720
AP-TD260K/300	605	12	2,00	12,540

►► AÇIKLAMALAR / INSTRUCTIONS :

NOT: DÖNÜŞ MODÜLLERİNDEKİ ÖZEL UYGULAMALAR İÇİN ÖRNEK SİPARİŞ h:40mm a:300mm b:200mm c:300mm "T" DÖNÜŞ

NOTE: The example order for special applications in bend modules. h:40mm. a:100mm b:200mm c:300mm "Tee branch".

Sipariş Kodu (Order Code)	a, b, c, d (mm)	h (mm)	t (mm)	Kg/Adet (Kg/Pcs.)
AP-DD305K/300	55	12	1,50	1,500
AP-DD307K/300	75	12	1,50	1,740
AP-DD310K/300	105	12	1,50	2,100
AP-DD312K/300	125	12	1,50	2,370
AP-DD315K/300	155	12	1,50	2,775
AP-DD320K/300	205	12	1,50	3,450
AP-DD325K/300	255	12	1,50	4,125
AP-DD330K/300	305	12	2,00	6,480
AP-DD340K/300	405	12	2,00	9,000
AP-DD350K/300	505	12	2,00	11,520
AP-DD360K/300	605	12	2,00	14,520

►►► AÇIKLAMALAR / INSTRUCTIONS :

NOT: DÖNÜŞ MODÜLLERİNDEKİ ÖZEL UYGULAMALAR İÇİN ÖRNEK SİPARİŞ h:40mm a:300mm b:200mm c:300mm d:200mm "Dörtlü" DÖNÜŞ

NOTE: The example order for special applications in bend modules. h:40mm. a:100mm b:200mm c:300mm d:200mm "crossing"

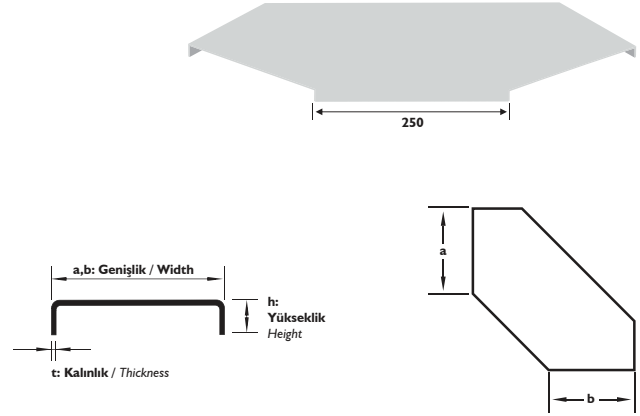
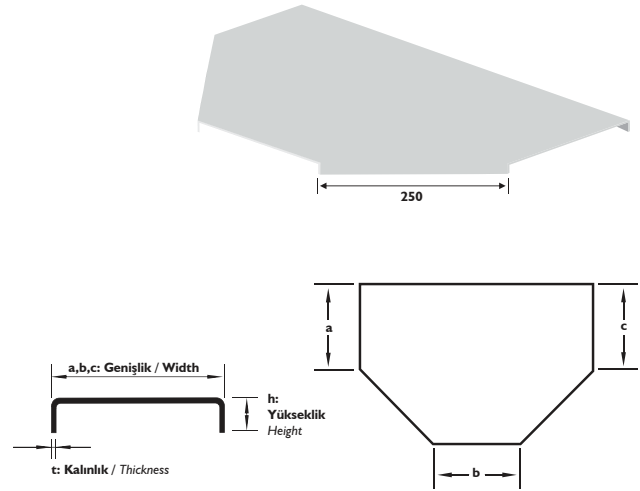
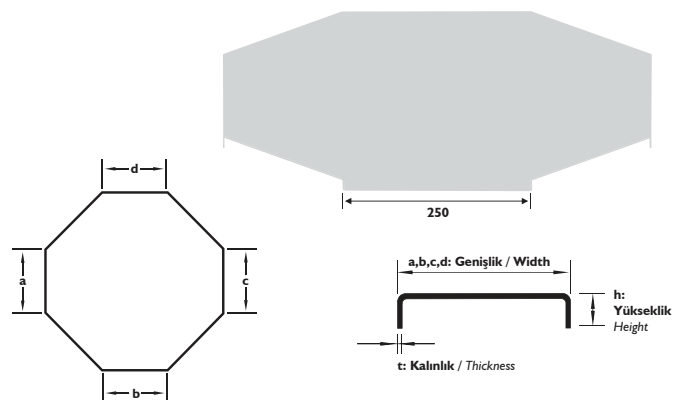
RADUS 300
90° DÖNÜŞ ELEMANI KAPAĞI
90° BEND COVER

RADUS 300
T DÖNÜŞ ELEMANI KAPAĞI
TEE BRANCH COVER

RADUS 300
DÖRTLÜ DÖNÜŞ ELEMANI KAPAĞI
CROSSING COVER

► AÇIKLAMALAR / INSTRUCTIONS :

! Ölçü toleransı ± 3 mm'dir.

! Belirtilen ağırlıklar kesim ağırlıklarıdır.

Note: The dimension tolerance is ± 3 mm

! The indicated weights are the weights before fabrication.

Sipariş Kodu (Order Code)	a, b (mm)	h (mm)	t (mm)	Kg/Adet (Kg/Pcs.)
AP-YD105K/450	55	12	1,50	0,525
AP-YD107K/450	75	12	1,50	0,585
AP-YD110K/450	105	12	1,50	0,675
AP-YD112K/450	125	12	1,50	0,825
AP-YD115K/450	155	12	1,50	1,050
AP-YD120K/450	205	12	1,50	1,425
AP-YD125K/450	255	12	1,50	2,108
AP-YD130K/450	305	12	2,00	2,790
AP-YD140K/450	405	12	2,00	4,440
AP-YD150K/450	505	12	2,00	6,060
AP-YD160K/450	605	12	2,00	7,980

► AÇIKLAMALAR / INSTRUCTIONS :

NOT: DÖNÜŞ MODÜLLERİNDEKİ ÖZEL UYGULAMALAR İÇİN ÖRNEK
SİPARİŞ h:40mm a:100mm b:200mm "90° Yatay Dönüş"

NOTE: The example order for special applications in bend modules.
h:40mm. a:100mm b:200mm Bend 90°.

Sipariş Kodu (Order Code)	a, b, c (mm)	h (mm)	t (mm)	Kg/Adet (Kg/Pcs.)
AP-TD205K/450	55	12	1,50	1,650
AP-TD207K/450	75	12	1,50	1,890
AP-TD210K/450	105	12	1,50	2,250
AP-TD212K/450	125	12	1,50	2,580
AP-TD215K/450	155	12	1,50	3,075
AP-TD220K/450	205	12	1,50	3,900
AP-TD225K/450	255	12	1,50	4,725
AP-TD230K/450	305	12	2,00	6,930
AP-TD240K/450	405	12	2,00	9,480
AP-TD250K/450	505	12	2,00	12,480
AP-TD260K/450	605	12	2,00	15,780

►► AÇIKLAMALAR / INSTRUCTIONS :

NOT: DÖNÜŞ MODÜLLERİNDEKİ ÖZEL UYGULAMALAR İÇİN ÖRNEK
SİPARİŞ h:40mm a:300mm b:200mm c:300mm "T" DÖNÜŞ

NOTE: The example order for special applications in bend modules.
h:40mm. a:100mm b:200mm c:300mm "Tee branch".

Sipariş Kodu (Order Code)	a, b, c, d (mm)	h (mm)	t (mm)	Kg/Adet (Kg/Pcs.)
AP-DD305K/450	55	12	1,50	2,700
AP-DD307K/450	75	12	1,50	3,030
AP-DD310K/450	105	12	1,50	3,525
AP-DD312K/450	125	12	1,50	3,930
AP-DD315K/450	155	12	1,50	4,538
AP-DD320K/450	205	12	1,50	5,550
AP-DD325K/450	255	12	1,50	6,563
AP-DD330K/450	305	12	2,00	9,180
AP-DD340K/450	405	12	2,00	12,120
AP-DD350K/450	505	12	2,00	15,360
AP-DD360K/450	605	12	2,00	18,960

►►► AÇIKLAMALAR / INSTRUCTIONS :

NOT: DÖNÜŞ MODÜLLERİNDEKİ ÖZEL UYGULAMALAR İÇİN ÖRNEK
SİPARİŞ h:40mm a:300mm b:200mm c:300mm d:200mm "Dörtlü" DÖNÜŞ

NOTE: The example order for special applications in bend modules.
h:40mm. a:100mm b:200mm c:300mm d:200mm "crossing"

RADUS 450

90° DÖNÜŞ ELEMANI KAPAĞI
90° BEND COVER

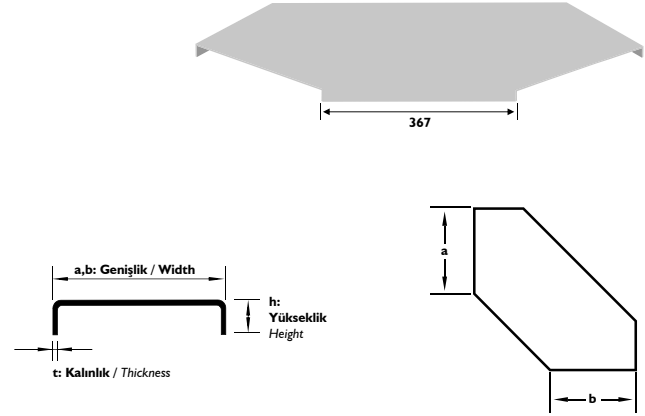

RADUS 450

T DÖNÜŞ ELEMANI KAPAĞI
TEE BRANCH COVER

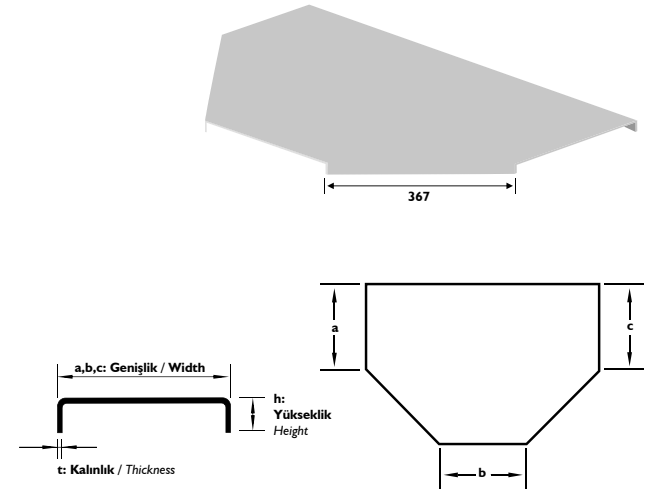

RADUS 450

DÖRTLÜ DÖNÜŞ ELEMANI KAPAĞI
CROSSING COVER

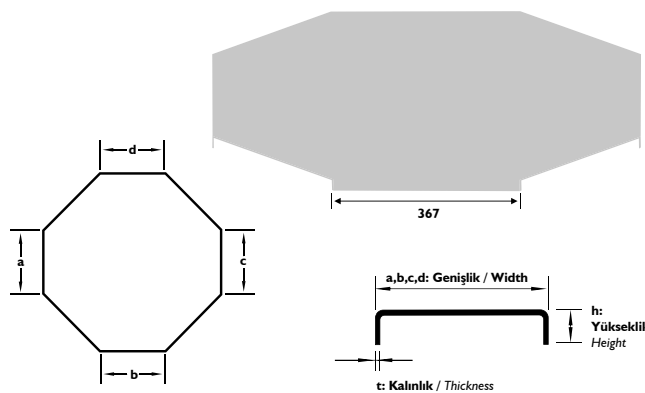

► AÇIKLAMALAR / INSTRUCTIONS :

! Ölçü toleransı ± 3 mm'dir.

! Belirtilen ağırlıklar kesim ağırlıklarıdır.

Note: The dimension tolerance is ± 3 mm

! The indicated weights are the weights before fabrication.

Sipariş Kodu (Order Code)	a, b (mm)	h (mm)	t (mm)	Kg/Adet (Kg/Pcs.)
AP-YD105K/600	55	12	1,50	0,675
AP-YD107K/600	75	12	1,50	0,735
AP-YD110K/600	105	12	1,50	0,825
AP-YD112K/600	125	12	1,50	1,005
AP-YD115K/600	155	12	1,50	1,275
AP-YD120K/600	205	12	1,50	1,725
AP-YD125K/600	255	12	1,50	2,528
AP-YD130K/600	305	12	2,00	3,330
AP-YD140K/600	405	12	2,00	5,040
AP-YD150K/600	505	12	2,00	6,960
AP-YD160K/600	605	12	2,00	9,120

► AÇIKLAMALAR / INSTRUCTIONS :

NOT: DÖNÜŞ MODÜLLERİNDEKİ ÖZEL UYGULAMALAR İÇİN ÖRNEK SİPARİŞ h:40mm a:100mm b:200mm "90° Yatay Dönüş"

NOTE: The example order for special applications in bend modules. h:40mm. a:100mm b:200mm Bend 90°.

Sipariş Kodu (Order Code)	a, b, c (mm)	h (mm)	t (mm)	Kg/Adet (Kg/Pcs.)
AP-TD205K/600	55	12	1,50	1,950
AP-TD207K/600	75	12	1,50	2,190
AP-TD210K/600	105	12	1,50	2,550
AP-TD212K/600	125	12	1,50	2,970
AP-TD215K/600	155	12	1,50	3,600
AP-TD220K/600	205	12	1,50	4,650
AP-TD225K/600	255	12	1,50	5,700
AP-TD230K/600	305	12	2,00	9,180
AP-TD240K/600	405	12	2,00	12,300
AP-TD250K/600	505	12	2,00	15,600
AP-TD260K/600	605	12	2,00	19,380

►► AÇIKLAMALAR / INSTRUCTIONS :

NOT: DÖNÜŞ MODÜLLERİNDEKİ ÖZEL UYGULAMALAR İÇİN ÖRNEK SİPARİŞ h:40mm a:300mm b:200mm c:300mm "T" DÖNÜŞ

NOTE: The example order for special applications in bend modules. h:40mm. a:100mm b:200mm c:300mm "Tee branch".

Sipariş Kodu (Order Code)	a, b, c, d (mm)	h (mm)	t (mm)	Kg/Adet (Kg/Pcs.)
AP-DD305K/600	55	12	1,50	3,600
AP-DD307K/600	75	12	1,50	4,320
AP-DD310K/600	105	12	1,50	5,400
AP-DD312K/600	125	12	1,50	5,940
AP-DD315K/600	155	12	1,50	6,750
AP-DD320K/600	205	12	1,50	8,100
AP-DD325K/600	255	12	1,50	9,450
AP-DD330K/600	305	12	2,00	12,870
AP-DD340K/600	405	12	2,00	16,260
AP-DD350K/600	505	12	2,00	20,040
AP-DD360K/600	605	12	2,00	24,000

►►► AÇIKLAMALAR / INSTRUCTIONS :

NOT: DÖNÜŞ MODÜLLERİNDEKİ ÖZEL UYGULAMALAR İÇİN ÖRNEK SİPARİŞ h:40mm a:300mm b:200mm c:300mm d:200mm "Dörtlü" DÖNÜŞ

NOTE: The example order for special applications in bend modules. h:40mm. a:100mm b:200mm c:300mm d:200mm "crossing"

RADUS 600

90° DÖNÜŞ ELEMANI KAPAĞI
 90° BEND COVER

RADUS 600

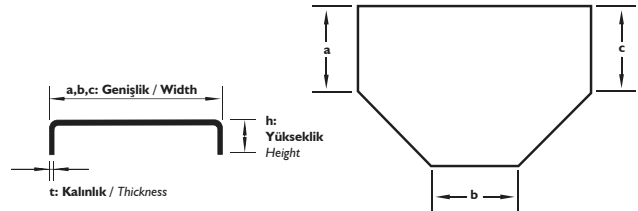
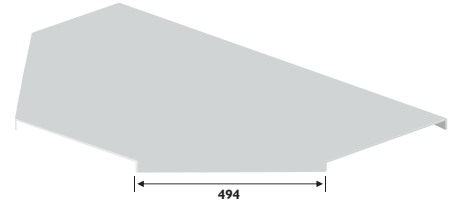
T DÖNÜŞ ELEMANI KAPAĞI
 TEE BRANCH COVER

RADUS 600

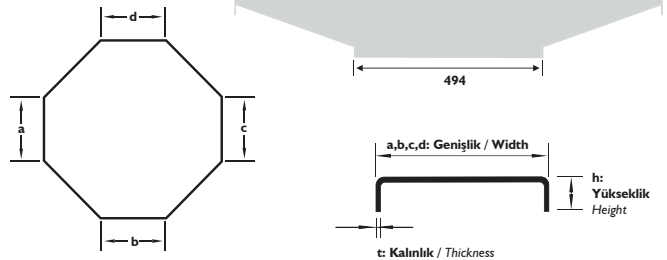
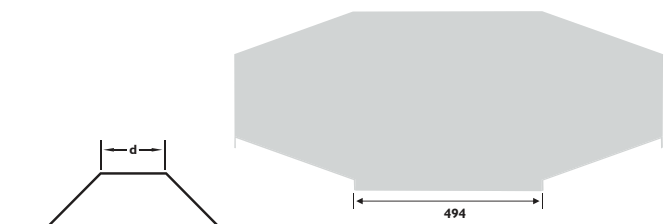
DÖRTLÜ DÖNÜŞ ELEMANI KAPAĞI
 CROSSING COVER

► AÇIKLAMALAR / INSTRUCTIONS :

! Ölçü toleransı ± 3 mm.'dir.

! Belirtilen ağırlıklar kesim ağırlıklarıdır.

Note: The dimension tolerance is ± 3 mm

! The indicated weights are the weights before fabrication.